

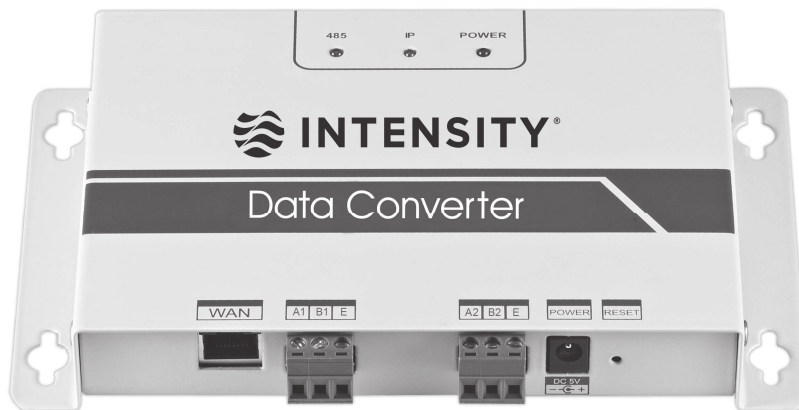

INTENSITY[®]
AIR CONDITIONING



DATA CONVERTER OPERATION MANUAL CCM15

OPERATION MANUAL

Thank you very much for purchasing our product.
Before using your unit, please read this manual carefully and keep it for future reference.



intensity.mx

MAN-O-CCM15-1017

- This manual gives detailed description of the precautions that should be brought to your attention during operation.
- In order to ensure correct service of the wired controller please read this manual carefully before using the unit.
- For convenience of future reference, keep this manual after reading it.



Table of Contents

I. Safety Precautions.....	1
II. Installation and Operation of the Data Converter.....	3
III. APP Function Description.....	12
IV. Web Client Operation.....	37
V. Remote Web Client Operation.....	38

I. Safety precautions



The following contents are stated on the product and the operation manual, including usage, precautions against personal harm and property loss, and the methods of using the product correctly and safely. After fully understanding the following contents (identifiers and icons), read the text body and observe the following rules.

- Identifier description

Identifier	Meaning
 Warning	Means improper handling may lead to personal death or severe injury.
 Caution	Means improper handling may lead to personal injury or property loss.

[Note]: 1. "Harm" means injury, burn and electric shock which need long-term treatment but need no hospitalization
2. "Property loss" means loss of properties and materials.

- Icon description

Icon	Meaning
	It indicates forbidding. The forbidden subject-matter is indicated in the icon or by images or characters aside.
	It indicates compulsory implementation. The compulsory subject-matter is indicated in the icon or by images or characters aside.

Warning

 Warning	Delegate installation	Please entrust the distributor or professionals to install the unit. The installers must have the relevant know-how. Improper installation performed by the user without permission may cause fire, electric, shock, personal injury or water leakage.
---	-----------------------	--

 Usage Warning	Forbid	Do not spray flammable aerosol to the wire controller directly. Otherwise, fire may occur.
	Forbid	Do not operate with wet hands or let water enter the wire controller. Otherwise, electric shock may occur.

II. Installation and Operation of the Data Converter

1. System structure diagram

The system mainly includes the central air conditioning system, data converter, router, App, cloud server, and Web client. The user can monitor the air conditioning system via App or Web client. The data converter is connected to the XYE bus of the air conditioner via port 485 of the air conditioner. The power supply is connected to the mains supply via an adapter. For the detailed connection, see the following figure:

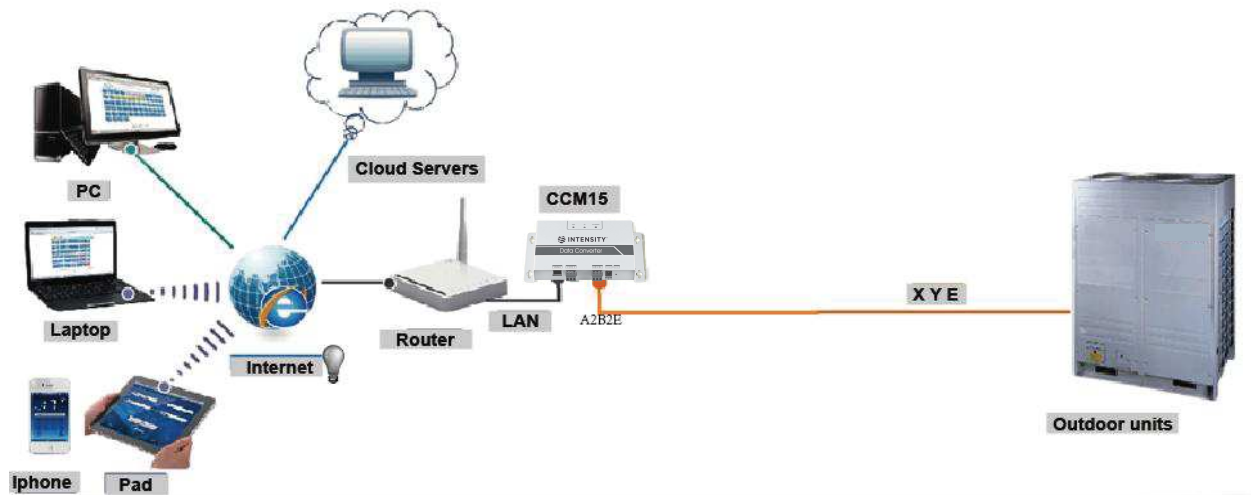

Fig.2.1 Schematic diagram of connecting the outdoor unit to the central air-conditioning system.



NOTE

It is recommended to wire from the Outdoor XYE port

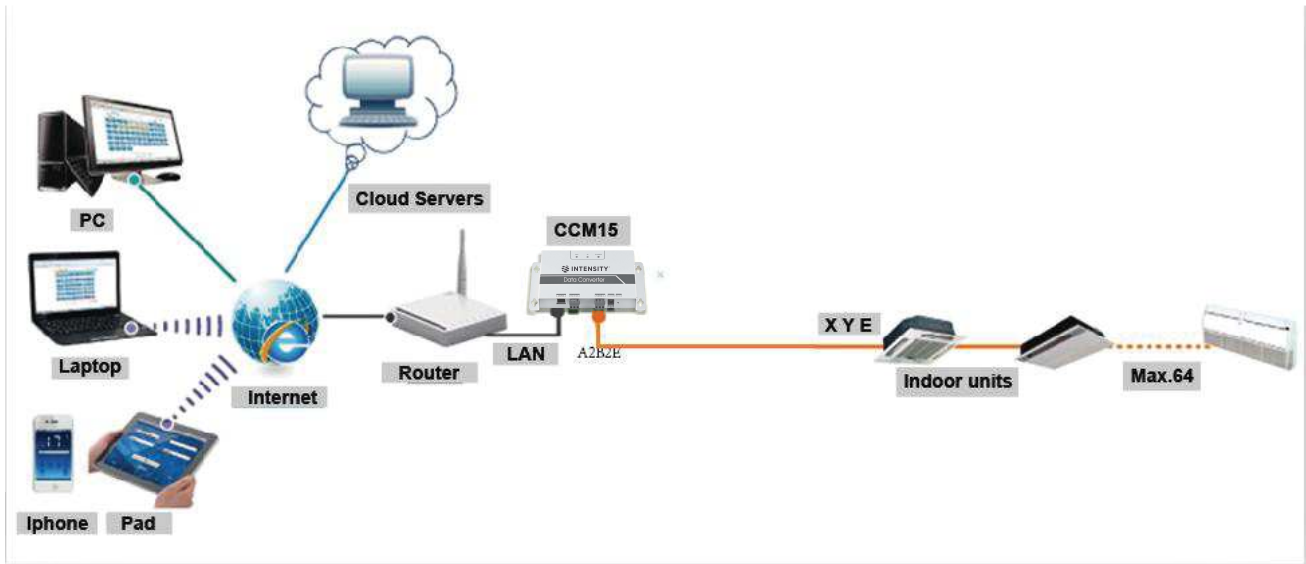

Fig.2.2 Schematic diagram of connecting the indoor unit to the central air-conditioning system.

If the data converter can only be connected to the outdoor unit, the outdoor unit shall be set to enable automatic addressing so that the indoor unit can be located. For multiple systems, port XYE of the outdoor unit is connected to the data converter in hand-in-hand manner. To use one LAN cable to connect multiple CCM15 gateways, associate CCM15 gateways with one router. For the configuration, see section 3.1.

Note: The new CCM15 is compatible with the V5X, V4+S, V4+R and Mini VRF outdoor units

For more information, please contact the technical support engineer

2. Hardware instruction

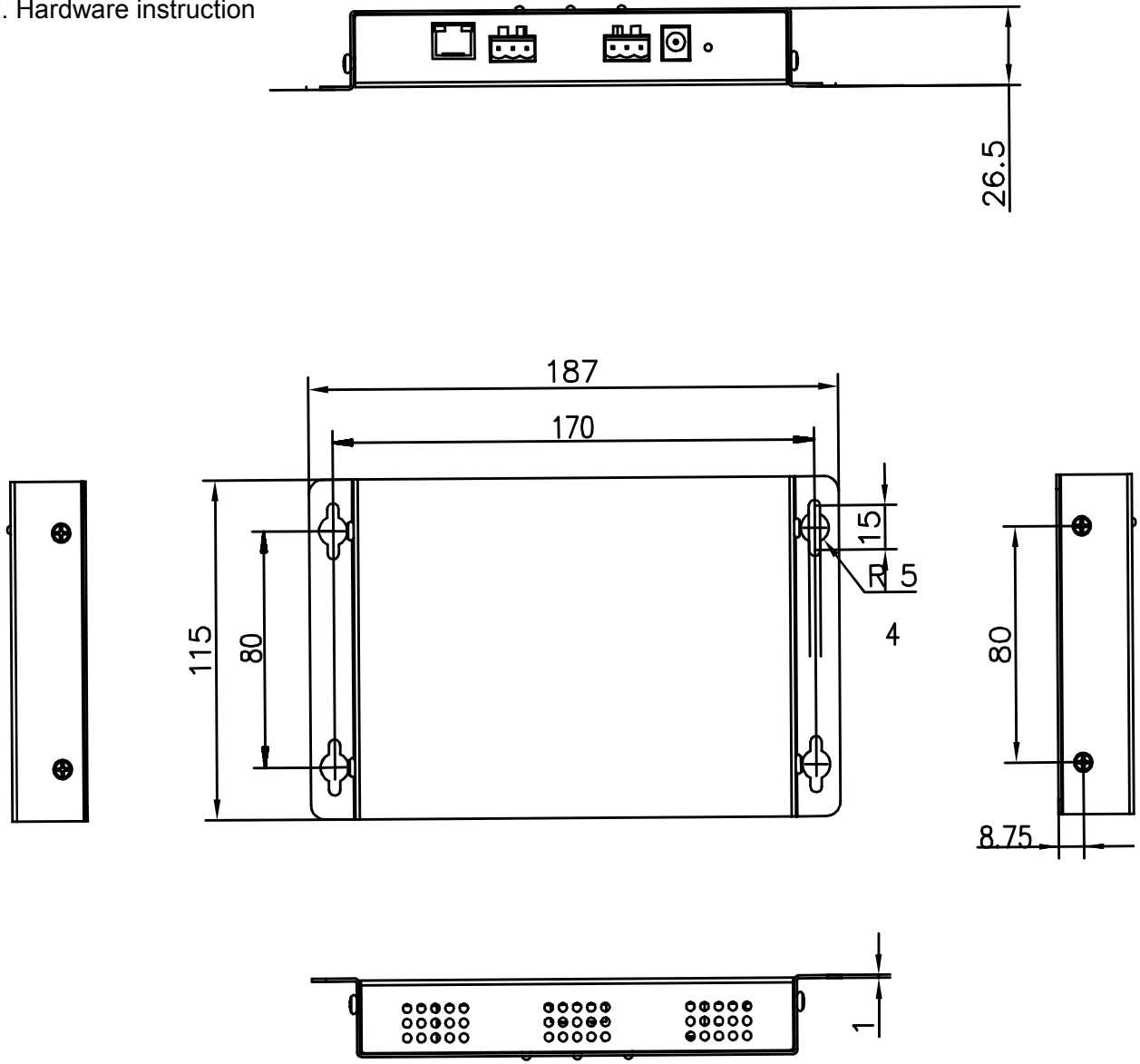

Fig.3.1 Structure dimension drawing

Input Voltage:DC5V

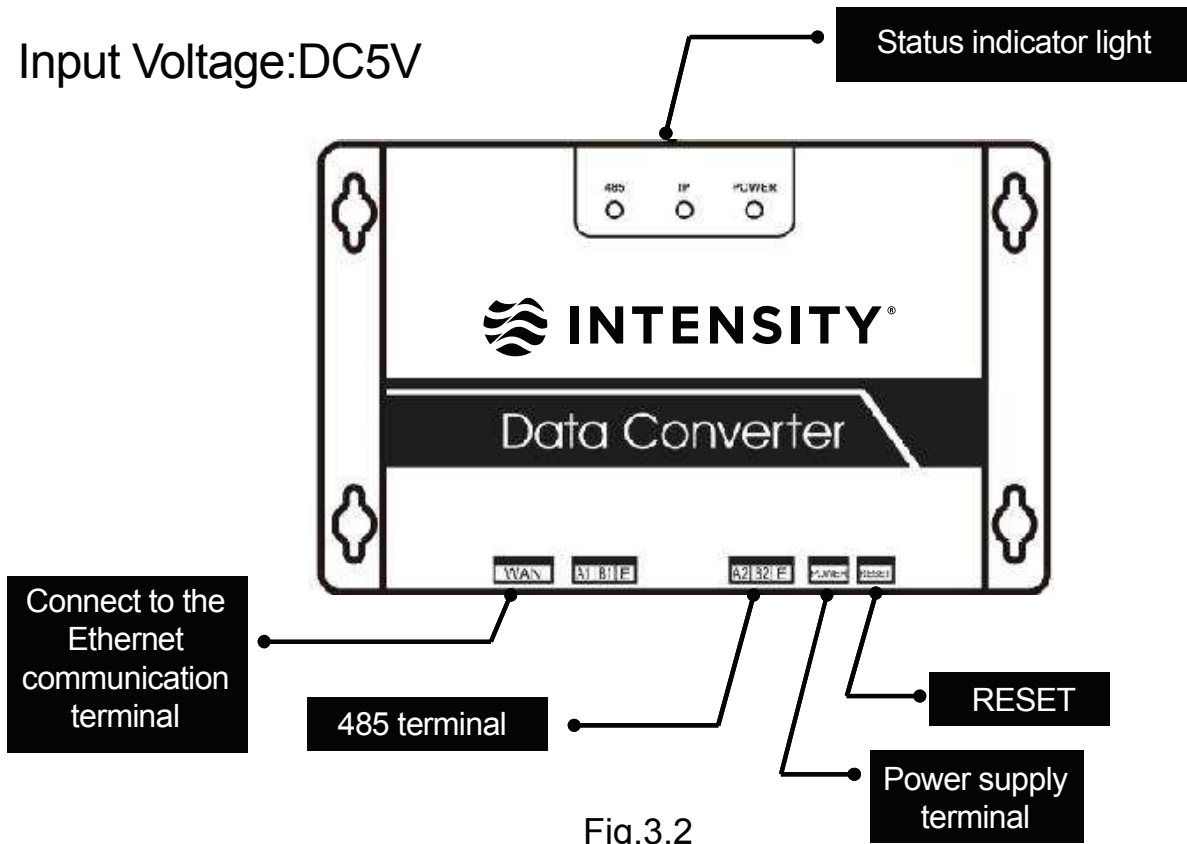
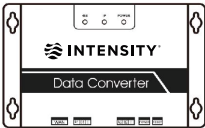





Fig.3.2

3. Instructions

1. Unpack the packing box to see if the accessories are all in readiness. Data converter is shown as the following figure:

Name	Qty.	Outline
Data Converter	1	
Installation operation manual	1	
Power adaptor	1	
Wiring 3-terminal and 1 bags of fixed screws	1	

2. Take the data converter out and power it on to see if the device is normal (POWER indicator lights up)

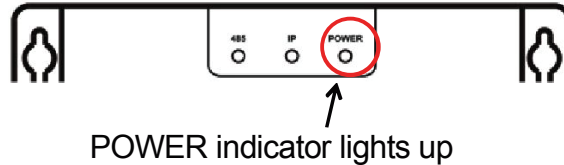

Fig.3.3

3. Data converter installation precautions

- a. Don't install it in the place where flammable gas leaks easily. Once flammable gas leakage occurs and stagnate around the device, it may result in fire.
- b. Keep the device from heating element as far as possible.
- c. Don't install it in the place that is too dirty or humid.

4. LED Indicators

POWER: It is a power indicator, indicating that the power supply of the system is normal and the system is running.

IP: It is a network communication indicator. When it flashes, it indicates that the data converter is accessing the Ethernet. When it is off, it indicates that the data converter is not accessing the Ethernet. In this case, check network connection and configuration.

485: It is an air conditioner communication indicator. When it flashes, it indicates that the communication between the air conditioner and data converter is normal. When it is off, it indicates that cable connection to port 485 is wrong or port 485 is not connected to an air conditioner.

The data converter is restarted upon detecting abnormal communication. (If port 485 does not communicate within 60s or the network port does not communicate within 3 minutes, the data converter is reset.) In this case, POWER, IP, and 485 indicators are on together.

LED indicator	Colour	Operating status	Description
485	Green	Flash	When the indicator flashes, it indicates that an air conditioner is connected.
IP	Green	Flash	When it flashes, it indicates that the data converter is accessing the Ethernet.
POWER	Red	Steady on	Power supply of the system is normal.

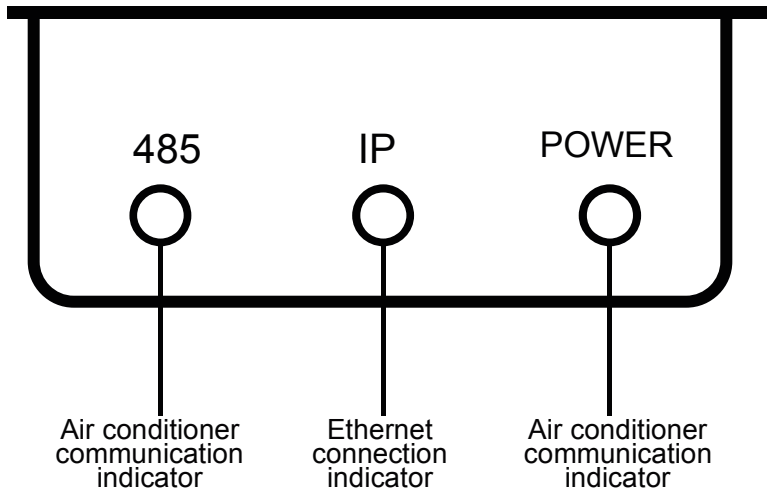
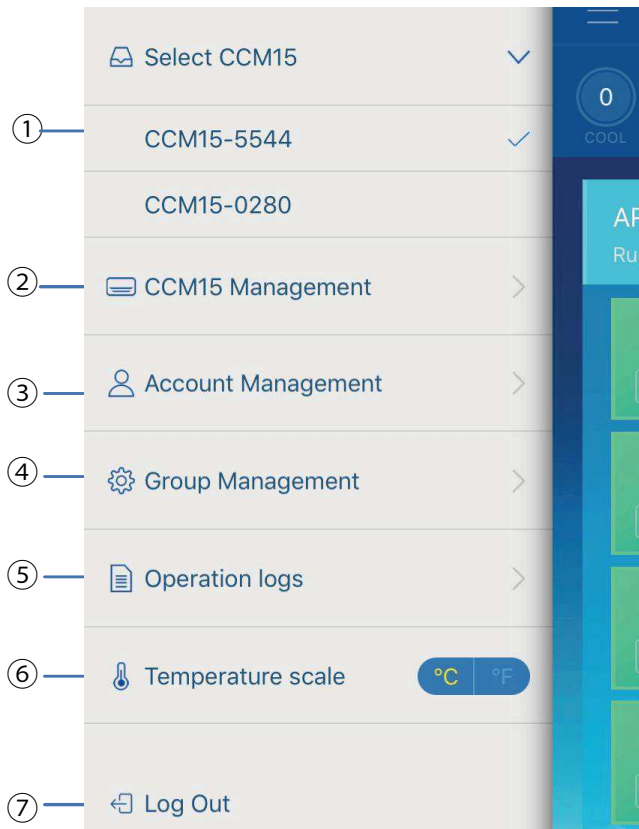

Figure 3 LED indicators

5. Getting an IP Address

By default, the IP address of the data converter is achieved by DHCP and allocated by the access router. Only when App and data converter are configured on one LAN, can App read the IP address of the data converter. To set a static IP address for the data converter, log in to the embedded



Web page of the data converter.

II. Function Description

The data convert supports Web, HTTP, TCP, and IP. Therefore, the user can remotely access the central conditioning VRF system via WAN. The App client on smart phones and Web client are available.

Function list of App client

- ① CCM15 list.
- ② CCM15 management.
- ③ Account management.
- ④ Group management.
- ⑤ Logs.
- ⑥ Temperature unit.
- ⑦ Log out.

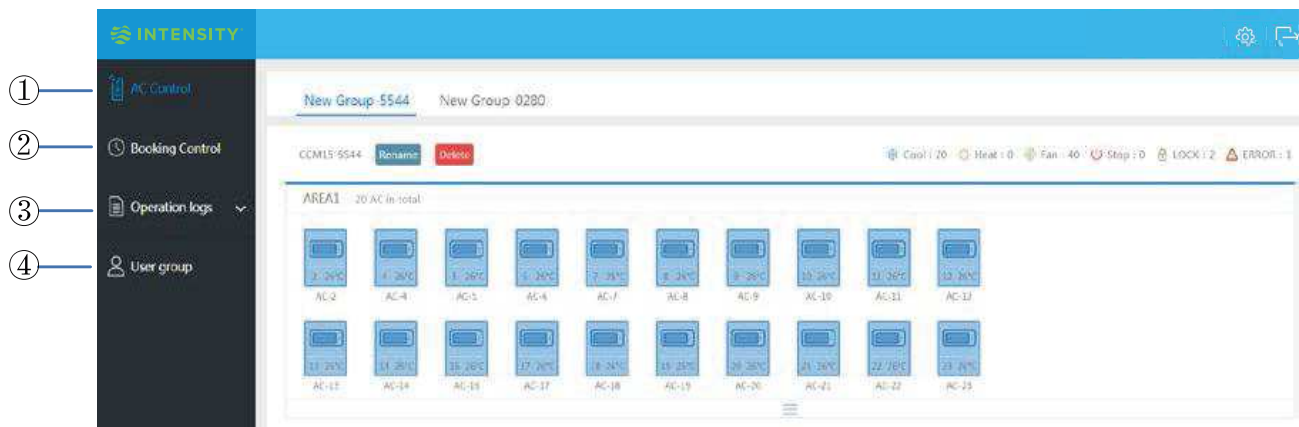

Web function list

- ① "AC Control": air conditioner control
- ② "Booking Control": scheduled operations
- ③ "Operation logs": operation logs
- ④ "User group": group management

APP download

IOS: Go to APP Store search "Green Control Intensity" to download the app

Android: Please ask to your Intensity Contractor for reference of the Android App.

III. APP Function Description

1. Registration Function

1-1 Registration Code

Before registering an account, the user must enter the registration code, as shown in the following figure. Open App client on the smart phone. Enter the registration code, such as Intensity, which is the first step. Then, click "OK". A login interface with the specified logo is displayed. See the following figure:(Note:Registration function only APP client)

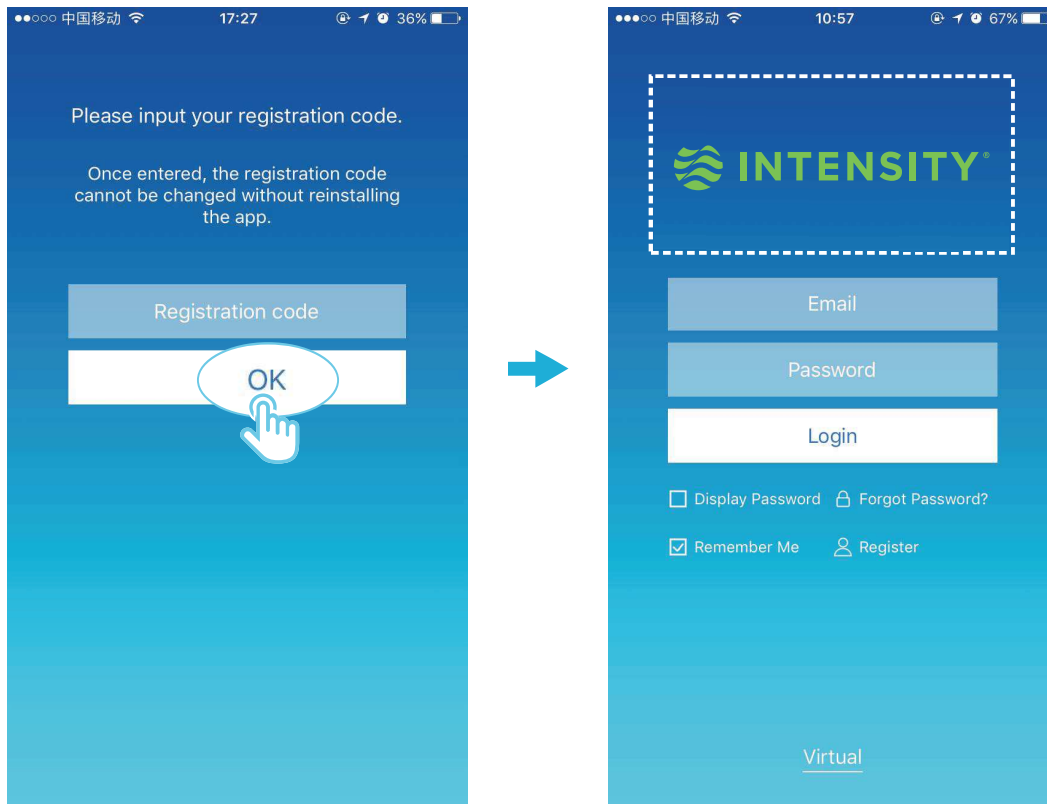

1-2 Account Registration

A registered account is used to manage devices and set management permissions. The registered account can also be used to log in to the App and Web clients.

Procedure:

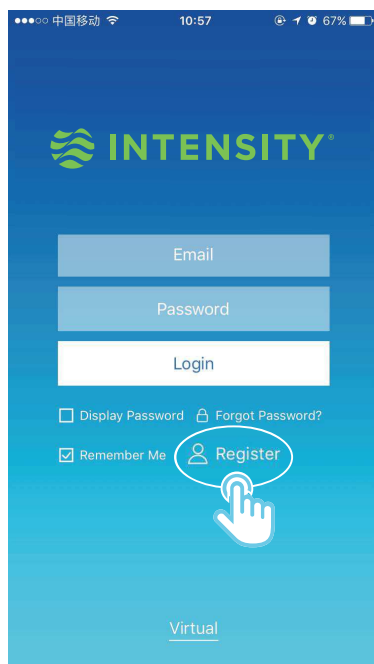

① Click "Register".

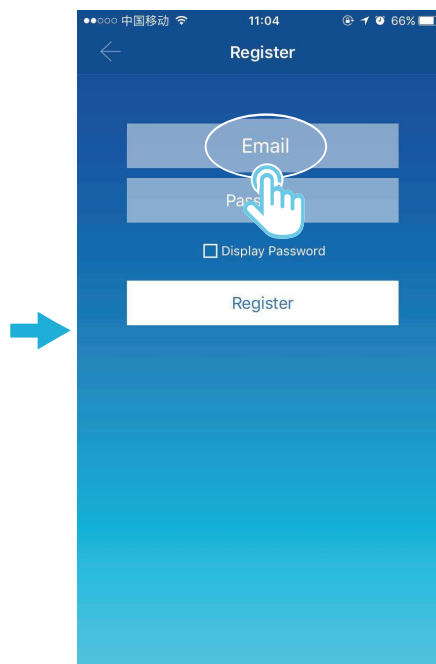

② Enter a valid email account and password. The account information is generated on the cloud platform.

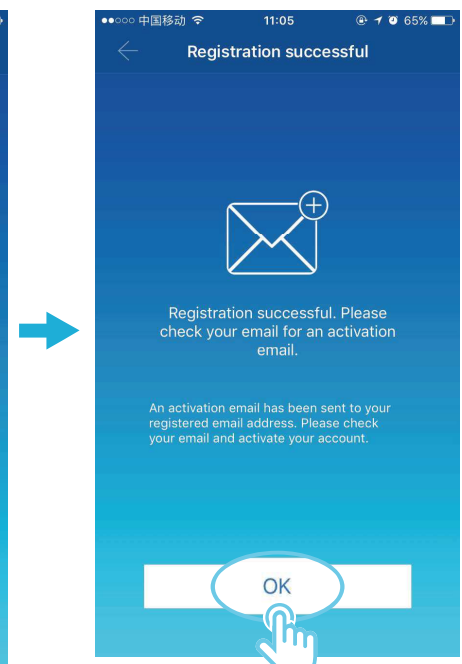

③ After registration is completed, activate the account via the email. Only the activated account can be used (Note:Email could be delayed)

2 Virtual function

The virtual experience function is used for showing the main interface , AC control, booking control and so on. Operation only available for choosing the unit of the temperature and setting the AC, the other menu and function are invalid in this function.

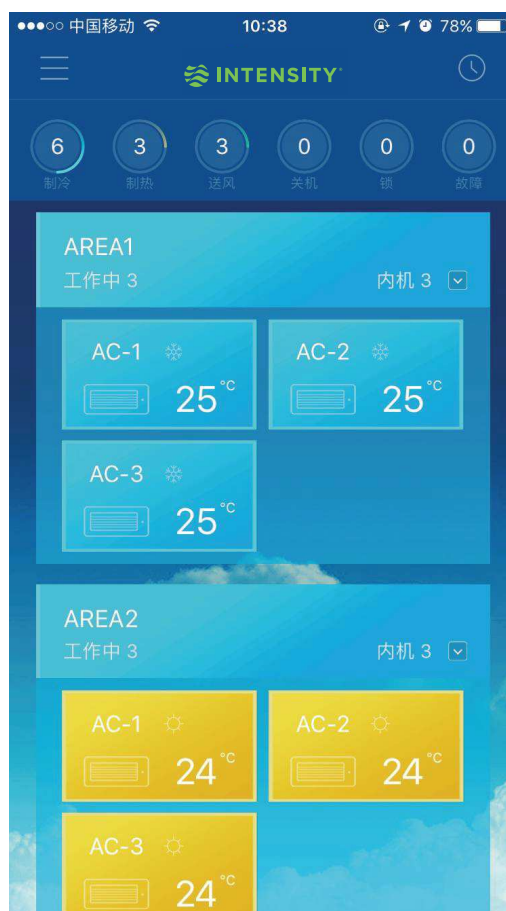
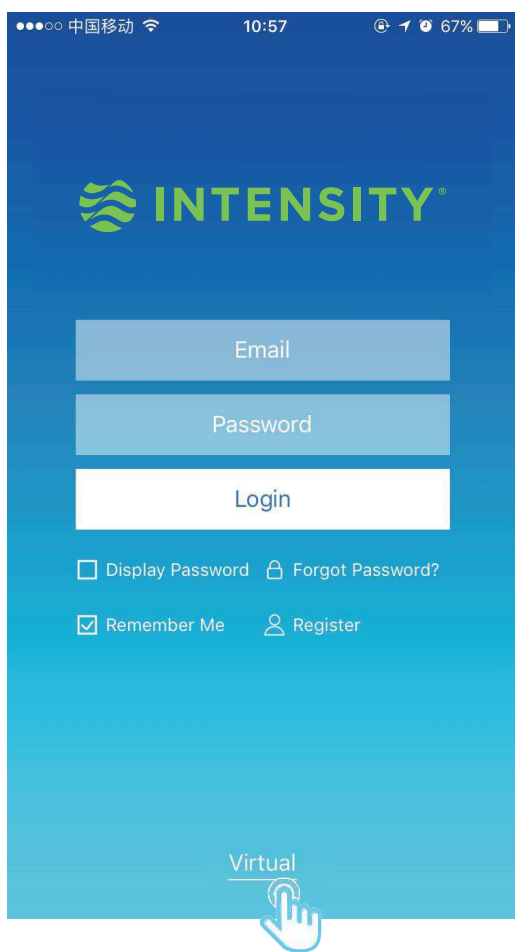

2. App Configuration

Refer to the guide to connecting the CCM15 and port XYE of the outdoor unit. Connect the CCM15 to the router. After login via App, the main interface prompts the user to configure the CCM15, as shown in the following figure:

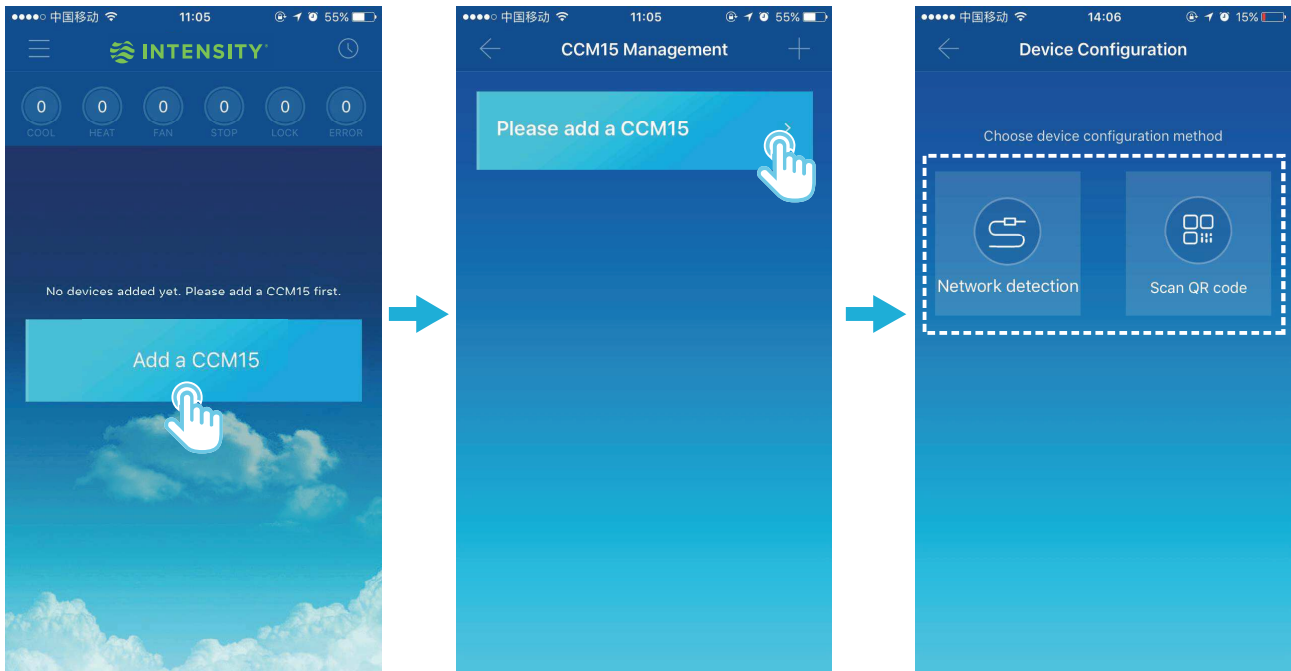

① prompts CCM15 configuration.

② displays the CCM15 configuration interface.

③ displays two configuration manners: using a network cable or scanning a QR code.



NOTE

Please connect the CCM15 to a network with administrator level permission, or not it may lead to security problems about account configuration.

2-1: Using a Network Cable

Only when the following conditions are met, can the user configure the CCM15 via a network cable:

- A. The CCM15 must access a wireless router.
- B. The smart phone and CCM15 must be located in one network segment and connected to one wireless router.
- C. The wireless router must access the Internet.

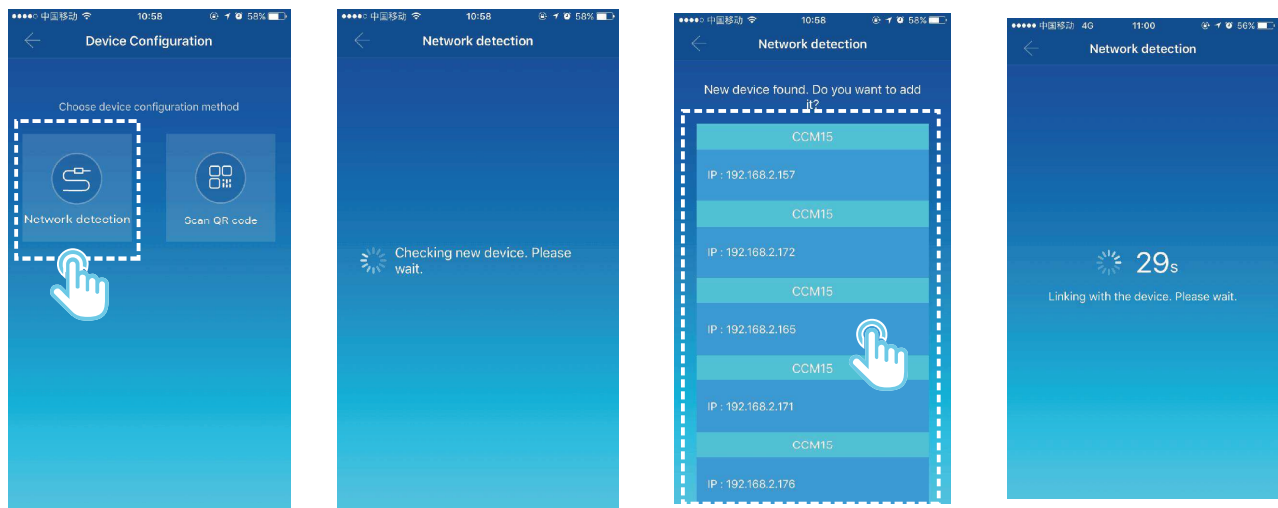

① Select a configuration manner.

② The App will search for the CCM15 devices on its LAN and displays the IP address of each CCM15 gateway. As shown in the figure above, ② displays multiple CCM15 devices found. Only one CCM15 device can be selected for configuration. Select one, and the system counts down. After configuration succeeds, it goes to the main interface for displaying devices.

Note: When one LAN accesses multiple CCM15 gateways, IP addresses of these gateways are displayed, as shown in ②. In this case, one-to-one correspondence between the CCM15 gateways and the IP addresses cannot be achieved. It is recommended that every time when the user completes configuring a CCM15 device, the user should timely rename the CCM15 device and record its IP address.

The following figure shows how to configure multiple CCM15 gateways:

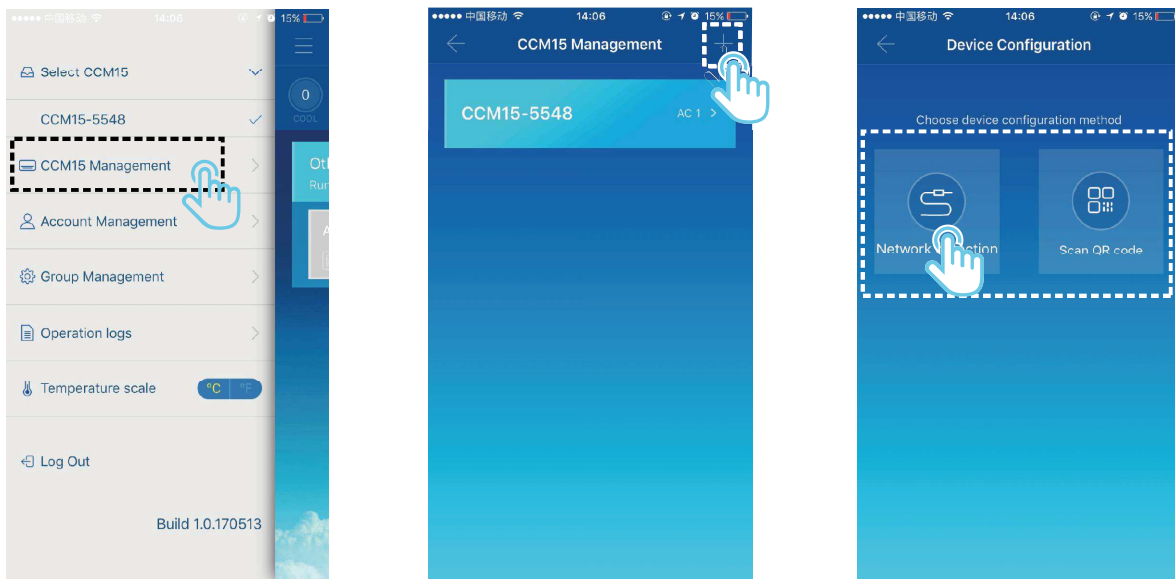

① Click "CCM15 Management". ② Click "+" at the upper right corner. The CCM15 configuration interface is displayed. ③ Select a configuration manner. The subsequent steps are the same as those for configuring the CCM15 via a network cable. Repeat the preceding steps to add multiple CCM15 devices until all the CCM15 devices are configured.

2-2 Scanning a QR Code

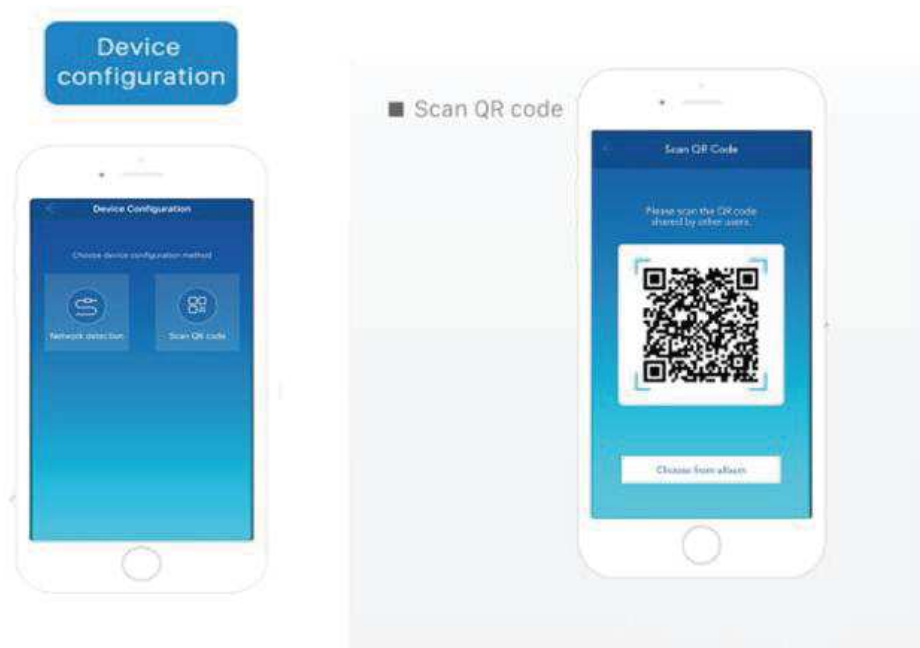

1) After registration, the new user directly goes to the device configuration interface.

2) Click "Scan QR code". It goes to the QR code scanning interface. Scan the QR code shared with other users to complete configuration.

Note: When the CCM15 is configured for the first time, the user must configure it via a network cable.

3 Editing an Area

3-1 Adding and Deleting an Area

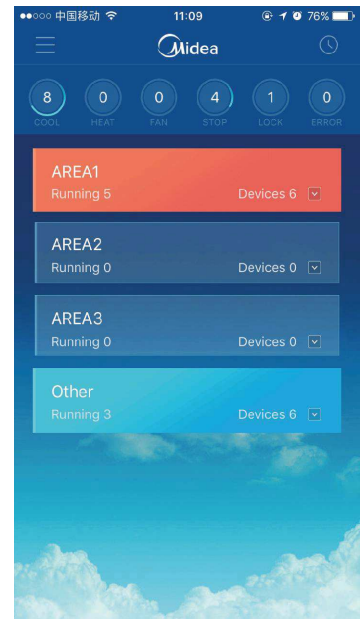
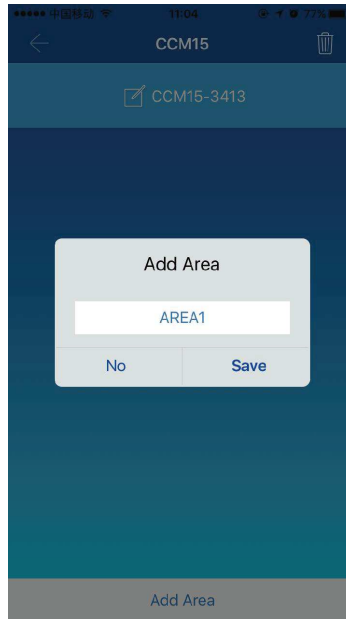
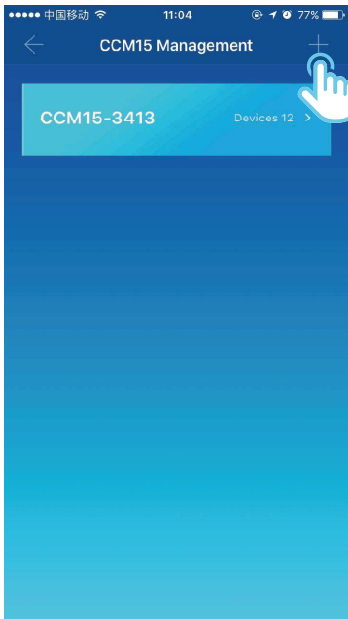

Adding an area: Click "+", as circled in the figure above. On the displayed interface, click "Add Area". Enter the name of the new area in the text box. Click "Save".

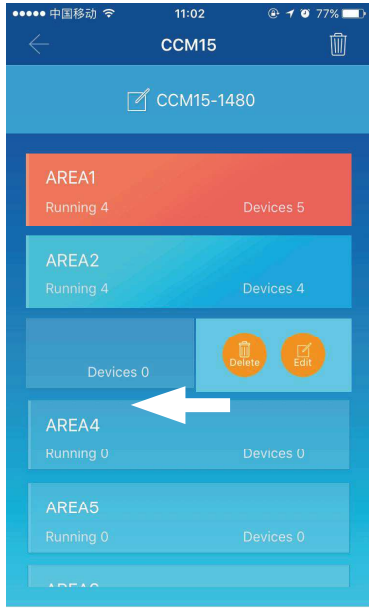

Add Area

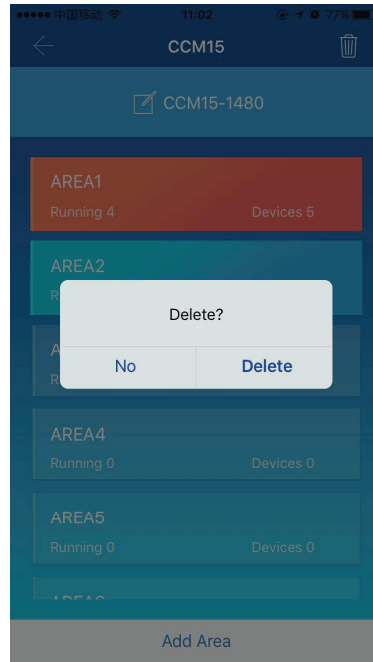

Deleting an area: On the selected area, slip left. Click "Delete" to delete the area. Click "Edit" to edit the area name.

3-2 Adding a Device to an Area

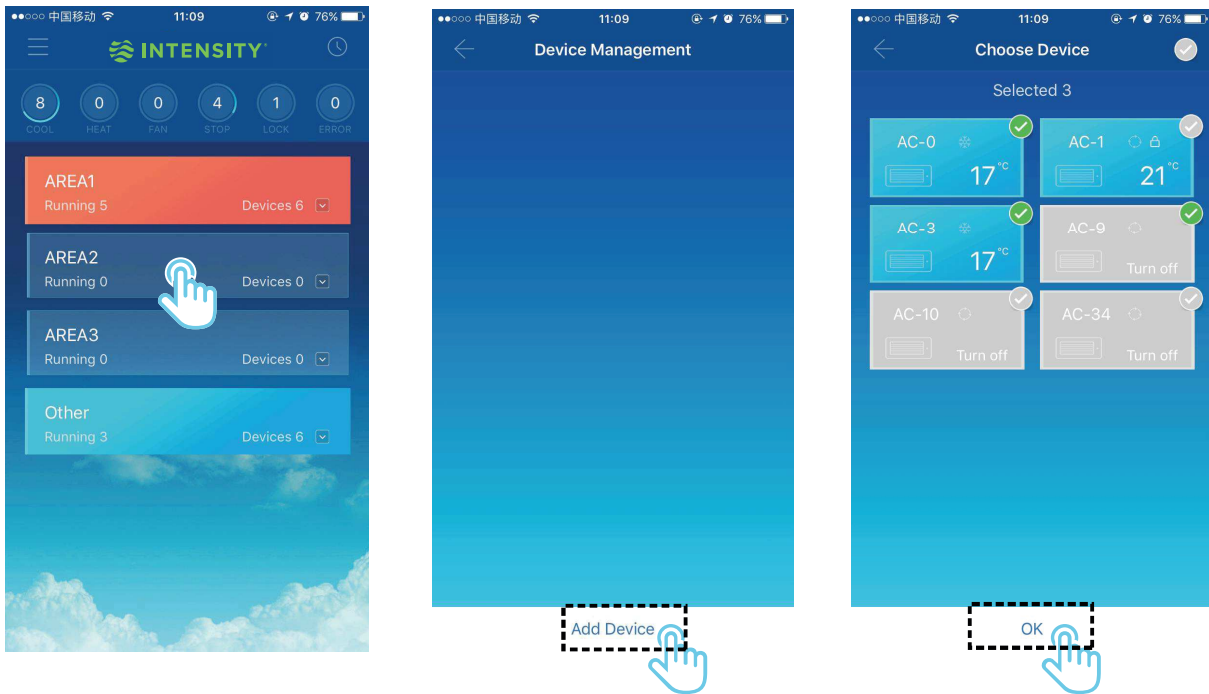

After an area is added, it goes back to the area display interface. Click the area to which a device is added. Click "Add Device". Select the device to be added. Click "OK".

3-3 Editing a Device in an Area

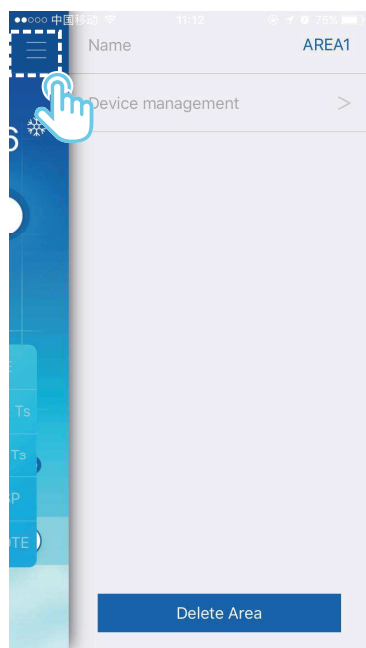

Click the icon indicated by ① at the upper right corner, as shown in the figure above. Click "Device management". The device management interface is displayed. Click "Add Device" indicated by ② to add a device or "Remove Device" to delete a device.

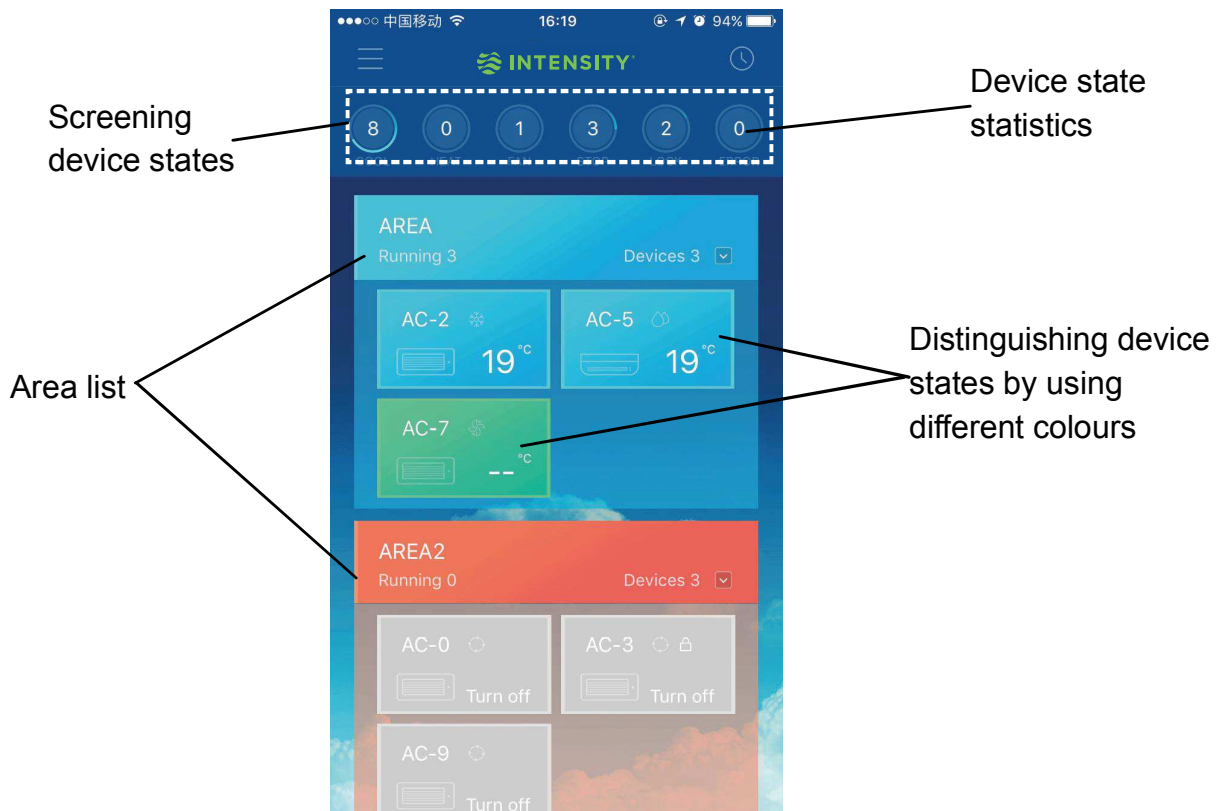

Statistics of device states: This area displays the number of air conditioners in each state.

Distinguishing device states by using different colours: This area displays the air conditioners in different states by using different colours, as shown in the following figures:

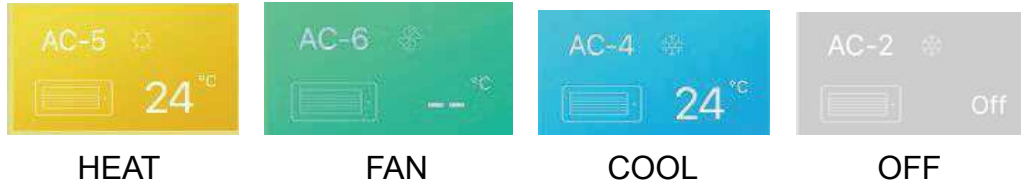

Screening device states: This area displays the air conditioners in the selected state.

3-4 Area Control Main Interface

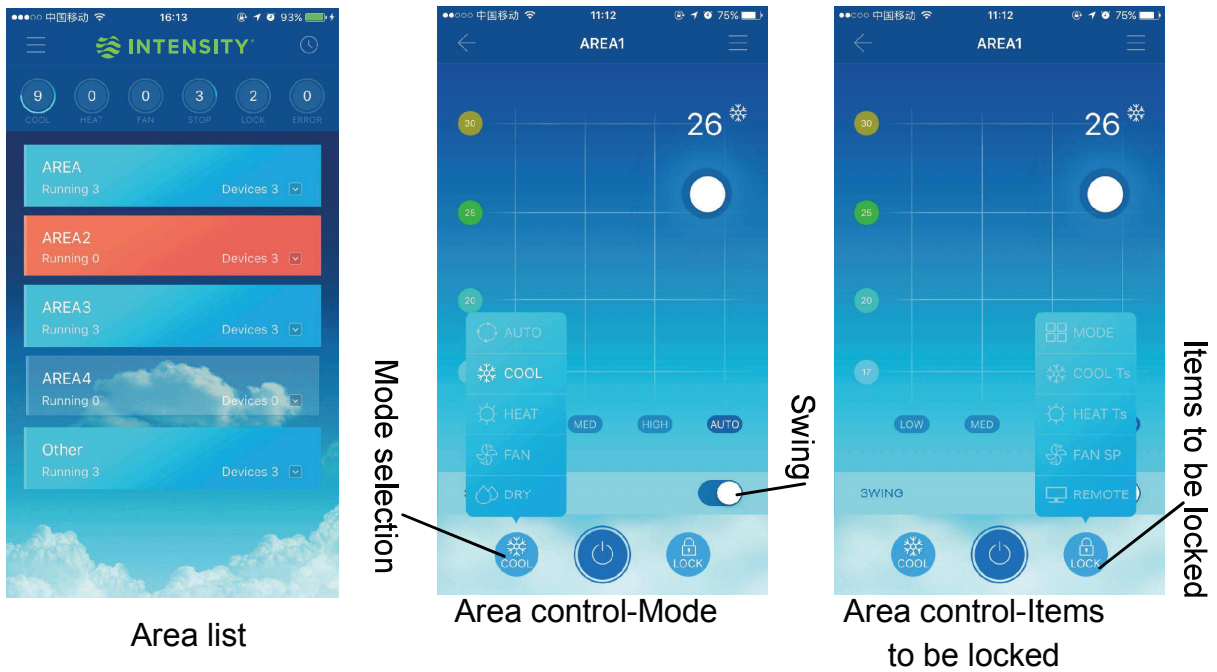

Area list: It displays area name, the number of running air conditioners in the area, and the total number of the air conditioners in the area.

Area colours: A blue area indicates that the devices in this area are running. A red area indicates that the devices in this area are not running. A transparent area indicates that no devices are located in this area. "Other" indicates grouped devices.

Area control: On the area control interface, ambient temperature is not displayed. The user can set temperature between 17°C and 30°C (62°F and 86°F) and select a fan speed (low, medium, high, and auto). Locking: The user can lock mode, cooling temperature, heating temperature, fan speed, and remote control.

4 Single Control Function of Air Conditioners

4-1 Air Conditioner Control

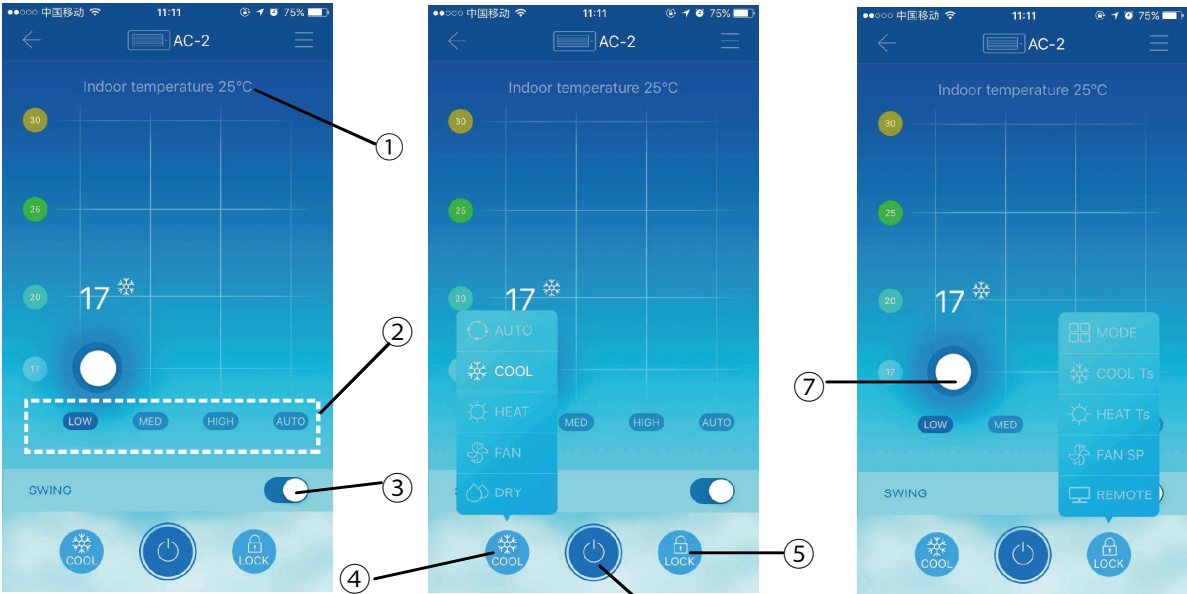

- ① It displays ambient temperature.
- ② It displays fan speed: "LOW", "MED", "HIGH", and "AUTO".
- ③ Swing
- ④ Select a mode: "AUTO", "COOL", "HEAT", "FAN", and "DRY".

- ⑤ Locking: The user can lock mode, cooling temperature, heating temperature, fan speed, and remote control.
- ⑥ Power on or off.
- ⑦ Set temperature between 17°C and 30°C (62°F and 86°F).

Note: If an air conditioner fails, the main interface displays the fault and the user cannot operate the interface.

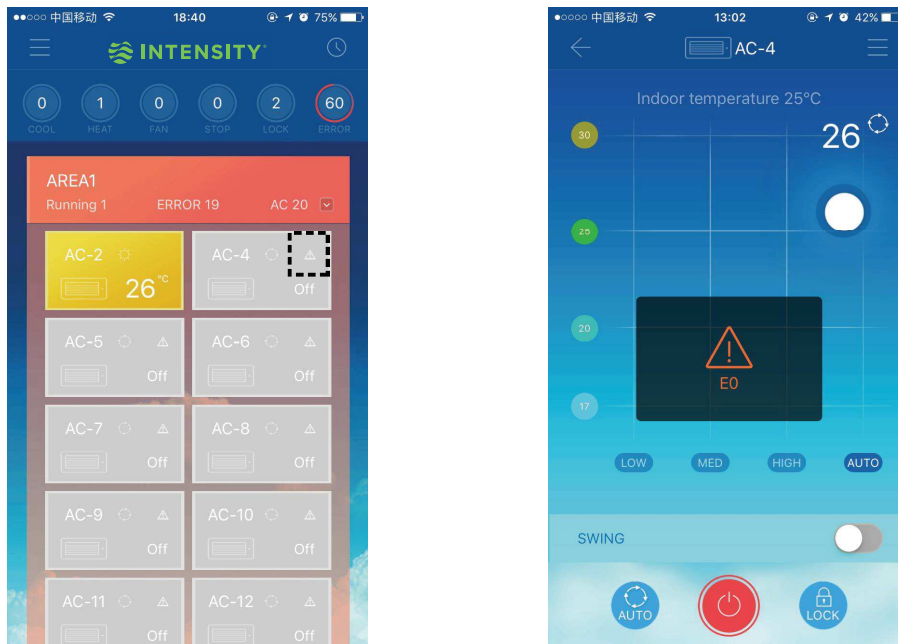

As shown in the figure above, when an air conditioner fails, the control interface displays fault information.

4-2 Modifying Device Name and Model

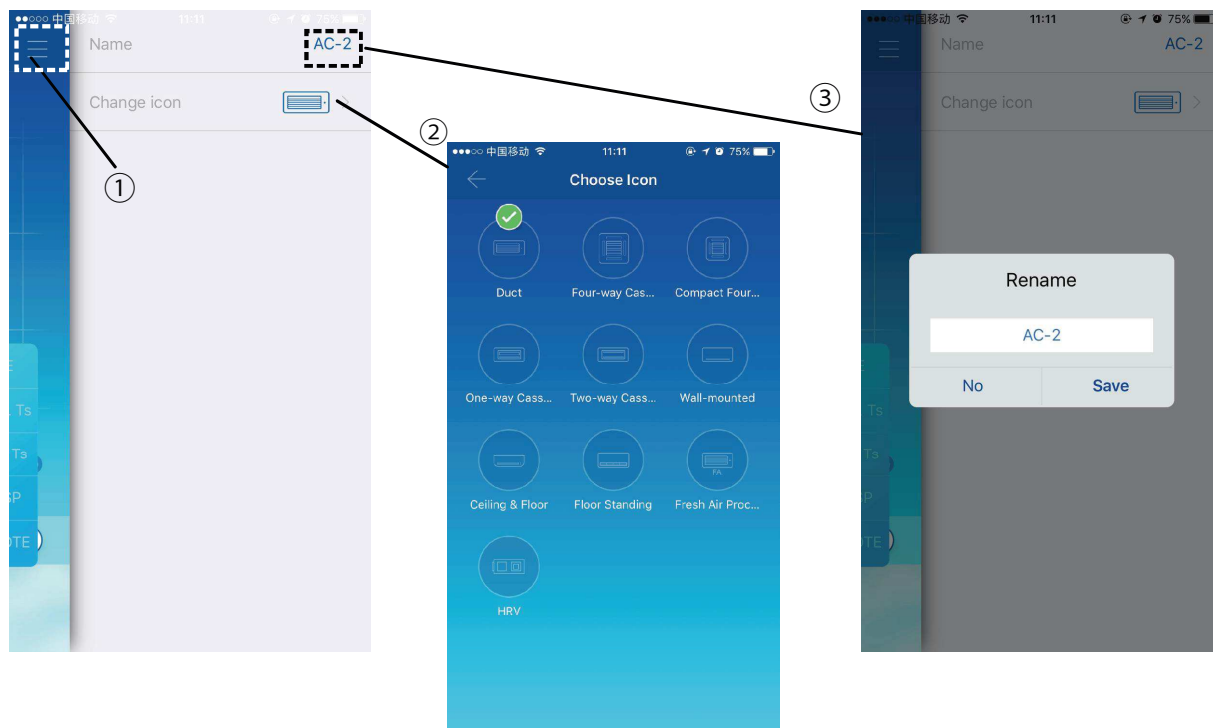

On the main control interface, click the icon indicated by ①, as shown in the figure above. The interface for modifying device names and models is displayed.

② It is an interface for modifying models. On this interface, ten models are available: "Duct", "Four-way Cassette", "Compact Four-way Cassette", "One-way Cassette", "Two-way Cassette", "Wall-mounted", "Ceiling & Floor", "Floor Standing", "Fresh Air Proc..." and "HRV".

③ It is an interface for renaming a device.

Note: The new CCM15 is compatible with the V5X, V4+S, V4+R and Mini VRF outdoor units and all kinds of indoor units except for the HRV and the Fresh Air Processing Unit. For more information, please contact the technical support engineer

5. Scheduled Control Function

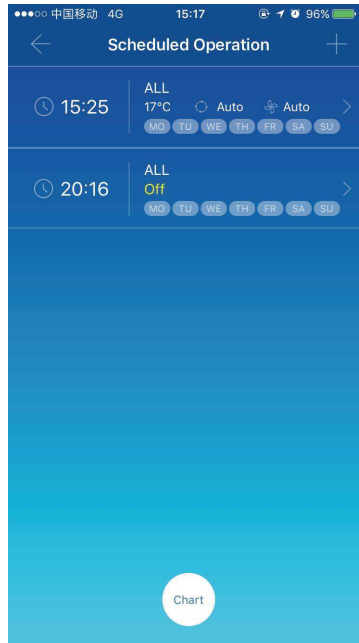

Displayed in a list

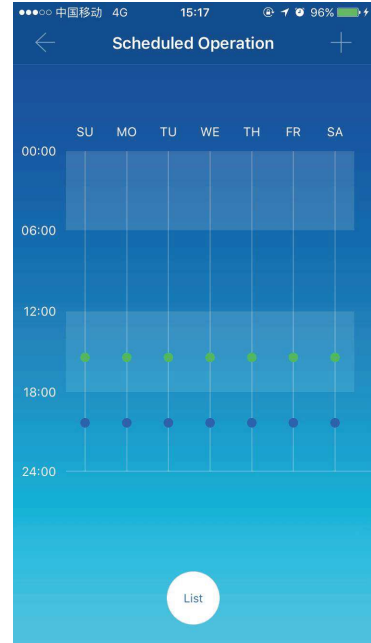

Displayed in a chart

Click the icon indicated by ①. The scheduled operation interface is displayed. Scheduled operations can be displayed in a chart or in a list.

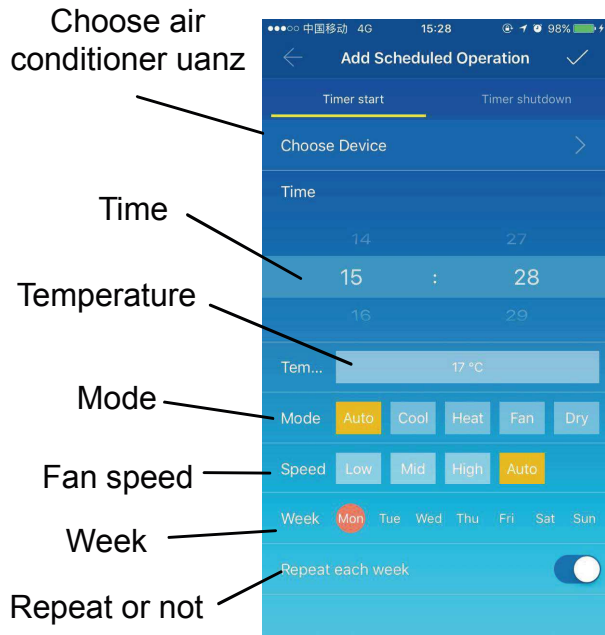

Choose air conditioner uanz

Time

Temperature

Mode

Fan speed

Week

Repeat or not

Scheduled power-on

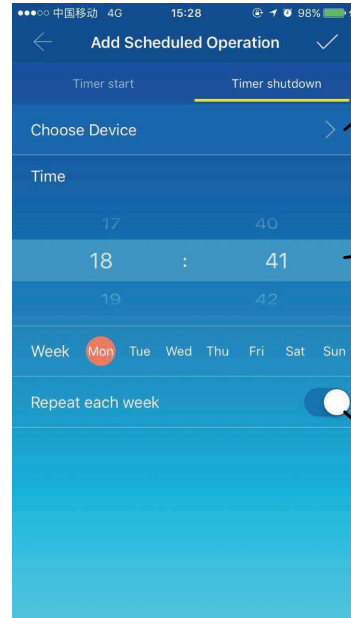

Choose an air conditioner.

Time

Week

Repeat or not

Scheduled power-off

After parameters are set, click  at the upper right corner to save the settings.

6 User Group Management

6-1 Inviting and Removing a User

Select a CCM15 device from the list, and then click "Group Management". The following interface is displayed:

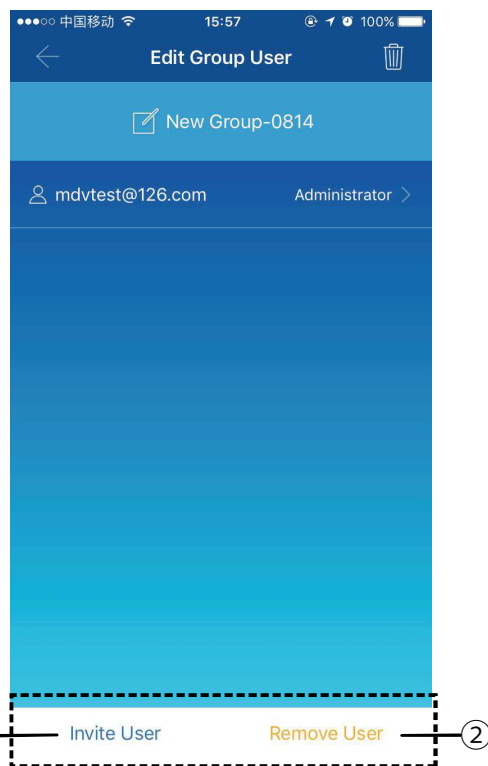
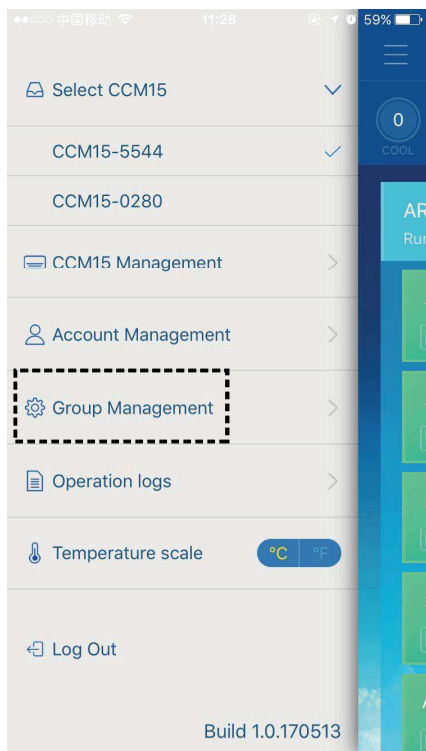

- ① "Invite User": If a QR code is displayed, a user can scan it to join the user group. The QR code is valid within 30 minutes. Up to 10 users can join one user group.
- ② "Remove User": Click it to remove a user from a user group.

6-2 Permission Management

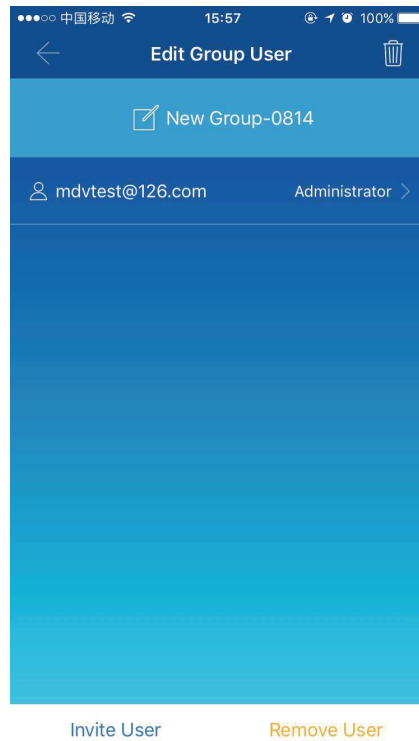

The figure above shows all the permissions of the members in a user group: "Invite/Remove users", "Change device information", "Device control", "Area control", "Lock function", and "View operations log".

7 Operation Logs

Click "Operation logs" on the left. The "Operation logs" interface is displayed, as shown in the following figure:

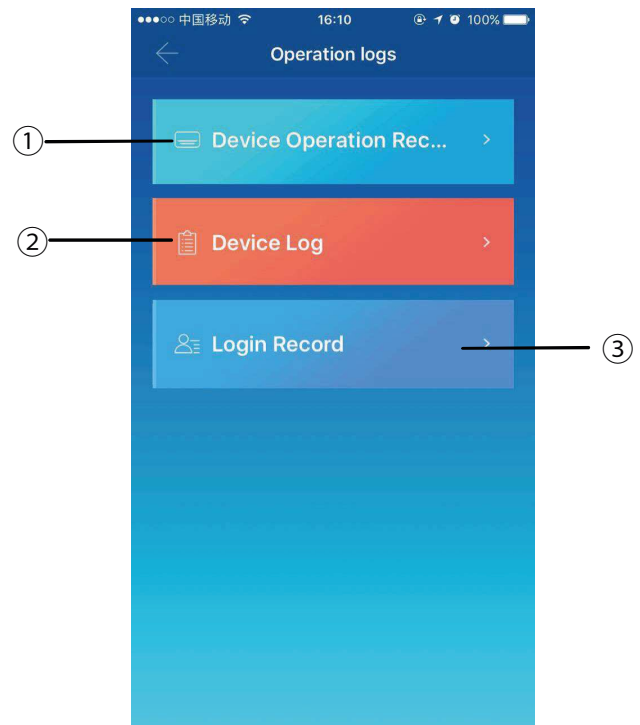
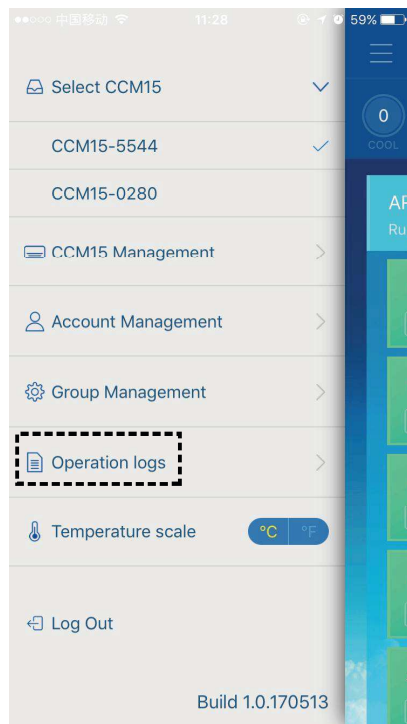

- ① "Device Operation Record"
- ② "Device Log"
- ③ "Login Record"

7-1 Device Logs

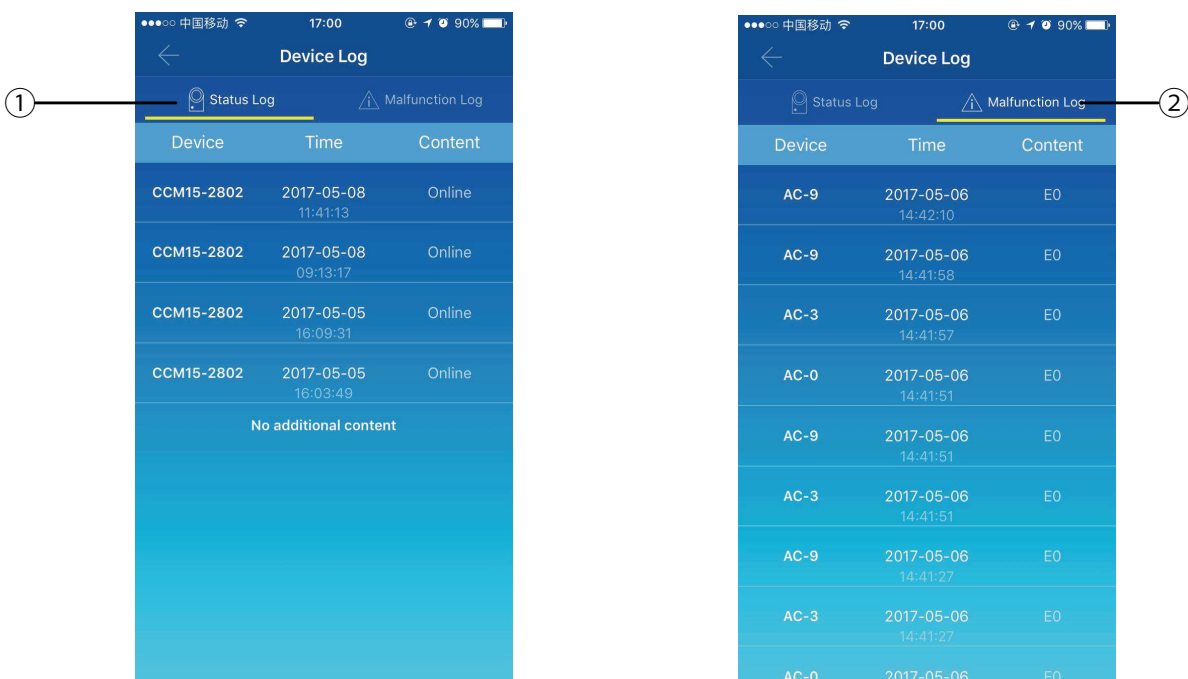

Device logs include status logs and malfunction logs:

- ① "Status Log": It displays gateway name, time, and status.
- ② "Malfunction Log": It displays device number, malfunction occurrence time, and error code.

7-2 Device Operation Records

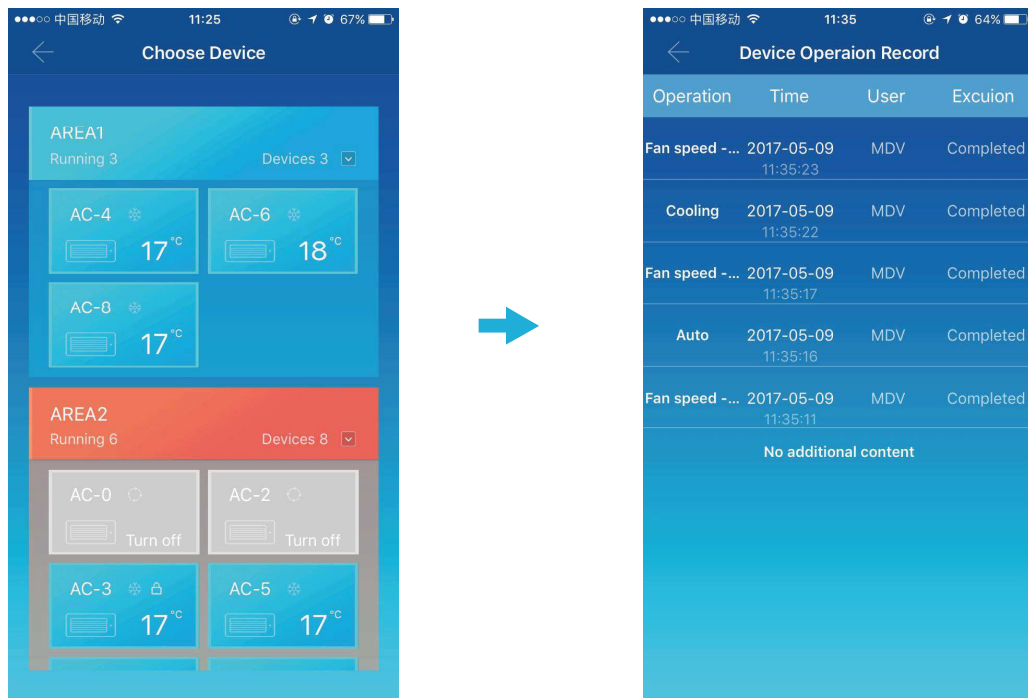

The "Device Operation Record" displays operation records of each device, including mode, operation time, user name, and execution status.

7-3 Login Records

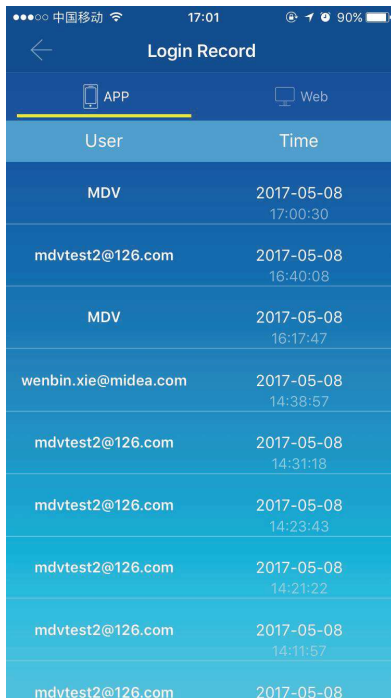

User	Time
MDV	2017-05-08 17:00:30
mdvtest2@126.com	2017-05-08 16:40:08
MDV	2017-05-08 16:17:47
wenbin.xie@midea.com	2017-05-08 14:38:57
mdvtest2@126.com	2017-05-08 14:31:18
mdvtest2@126.com	2017-05-08 14:23:43
mdvtest2@126.com	2017-05-08 14:21:22
mdvtest2@126.com	2017-05-08 14:11:57
mdvtest2@126.com	2017-05-08

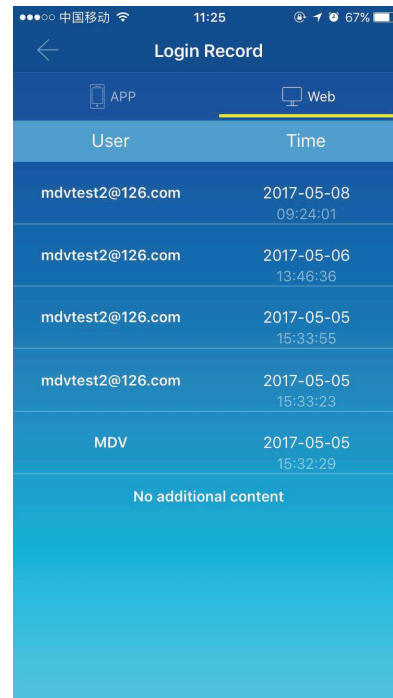

User	Time
mdvtest2@126.com	2017-05-08 09:24:01
mdvtest2@126.com	2017-05-06 13:46:36
mdvtest2@126.com	2017-05-05 15:33:55
mdvtest2@126.com	2017-05-05 15:33:23
MDV	2017-05-05 15:32:29
No additional content	

Login records are classified into App login records and Web login records:

- ① "APP": It displays login user name and login time via the App client.
- ② "Web": It displays login user name and login time via the Web client.

8 Account Management

Click "Account Management". The account management interface is displayed, as shown in the following figure:

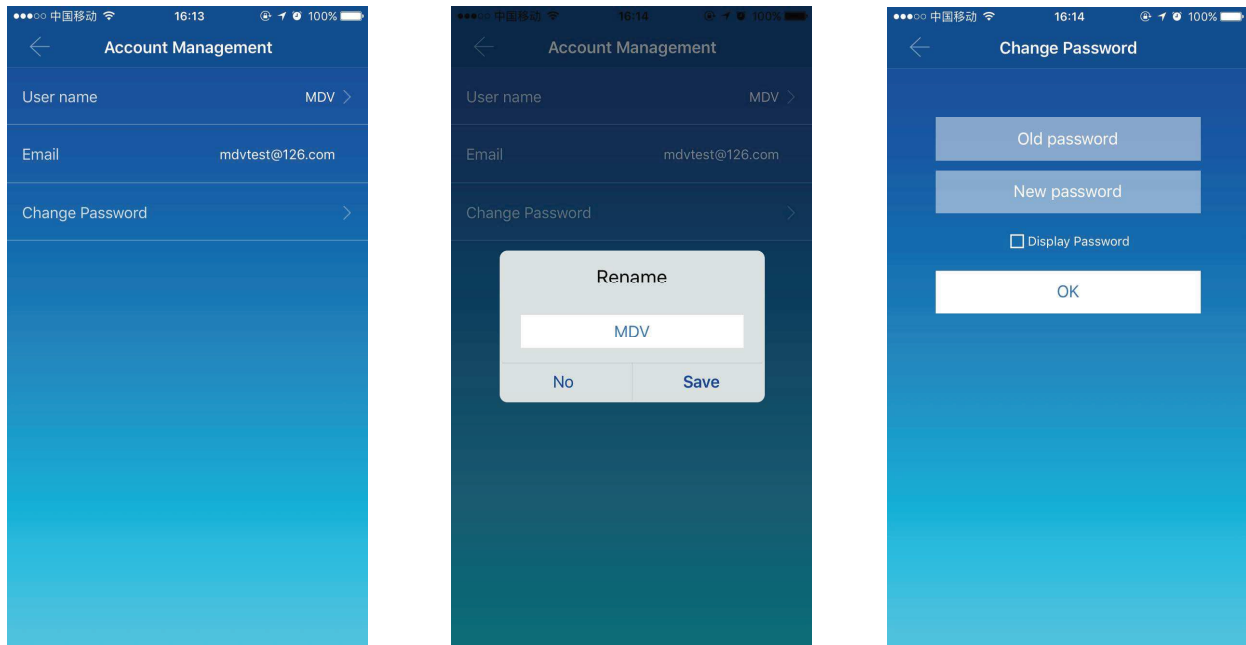

- ① Click the user name. The "Rename" dialog box is displayed. Enter a new name, and then click "Save".
- ② Click "Change Password". On the "Change Password" interface, enter the old and new passwords. Click "OK". The password must contain at least 6 characters.

IV. Web Client Operation

When the CCM15 gateway is configured on the App client, the IP address of the CCM15 gateway is displayed. On a PC located in the same network segment of the CCM15 gateway, type the IP address of the CCM15 gateway into the browser's address bar. The embedded Web page of the CCM15 gateway is displayed: Click "Config." to edit the IP address of the CCM15 gateway. The IP address can be set to a dynamic IP address or a static IP address.

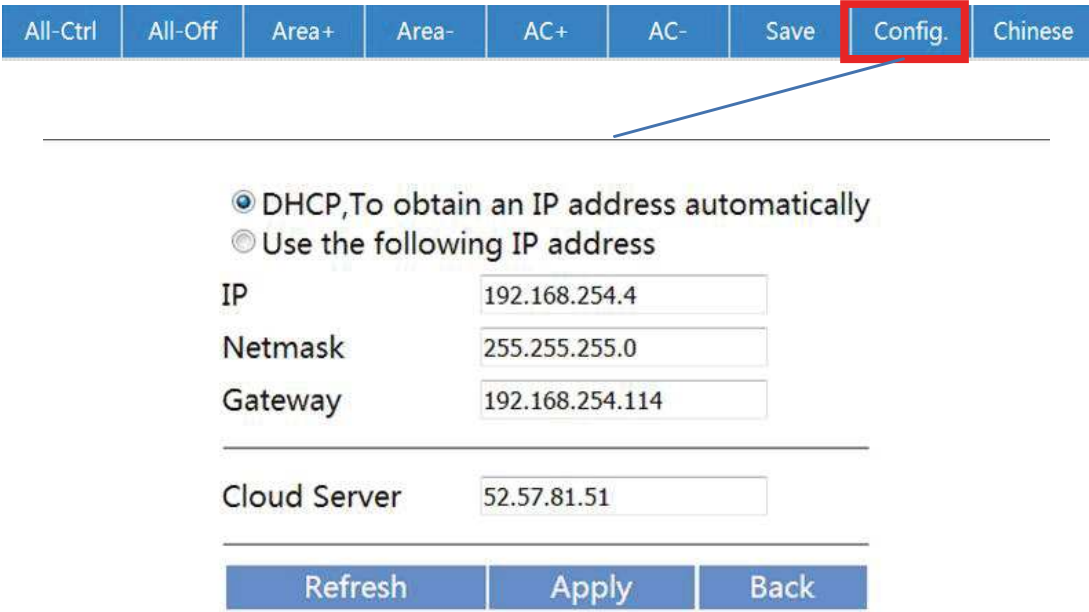

The screenshot shows a navigation bar with buttons: All-Ctrl, All-Off, Area+, Area-, AC+, AC-, Save, Config., and Chinese. The 'Config.' button is highlighted with a red box. Below the navigation bar, there are two radio button options:
● DHCP, To obtain an IP address automatically (selected)
○ Use the following IP address
Below these options are input fields for:
IP: 192.168.254.4
Netmask: 255.255.255.0
Gateway: 192.168.254.114
Cloud Server: 52.57.81.51
At the bottom, there are three buttons: Refresh, Apply, and Back.

Note: the WEB Client is only used for configuring the IP address of CCM15. Please use the app or Remote WEB Client to control the AC.

V. Remote Web Client Operation

1. Log in

Browser support: IE 10 or above, Firefox, Chrome, Safari

Operating systems: Windows7 or above, Mac OS

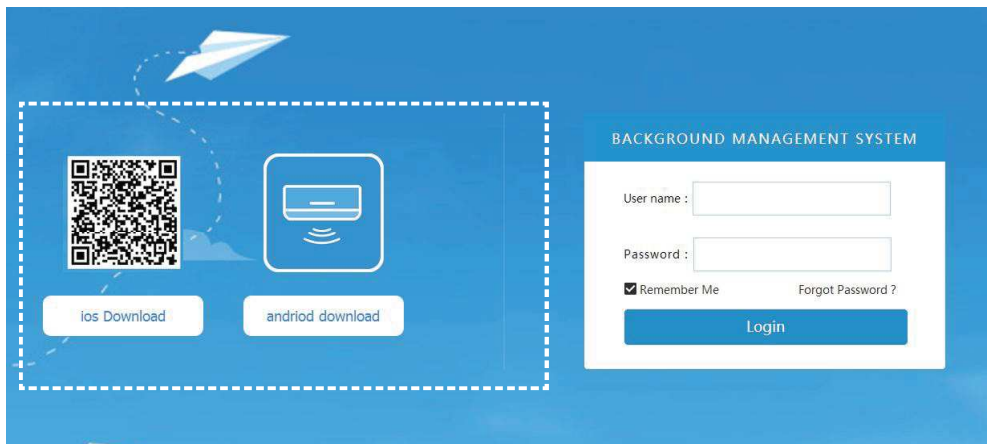

The login interface is displayed. Enter the registered email address in the "User name" text box and password in the "Password" text box. Click "Login". An account can only be registered on the App client. Only after the account is activated can it be used for login on the Web client.

The frame selected in the above interface is a link to download the app. iOS and android are available.

Tick "Remember Me" to remember user account and password. When the user accesses this address next time, the user can directly log in.

Click "Forgot Password" to retrieve the password, as shown in the following figure:

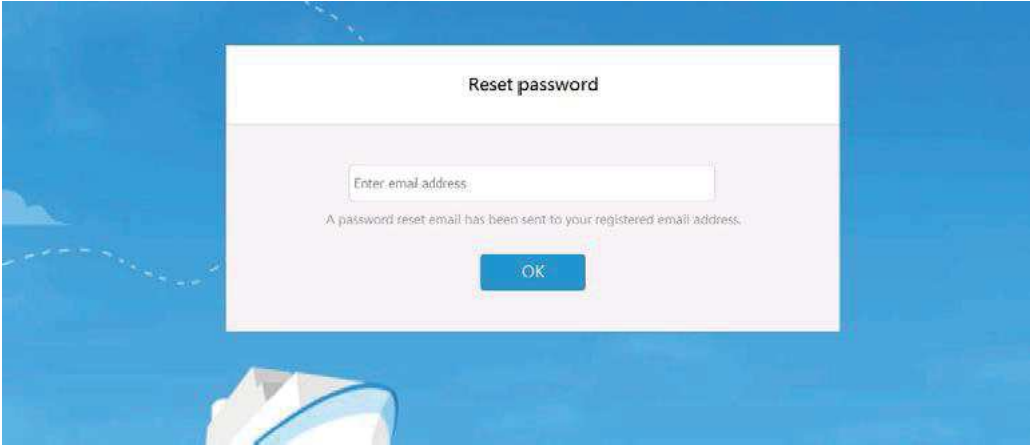

2. Function areas

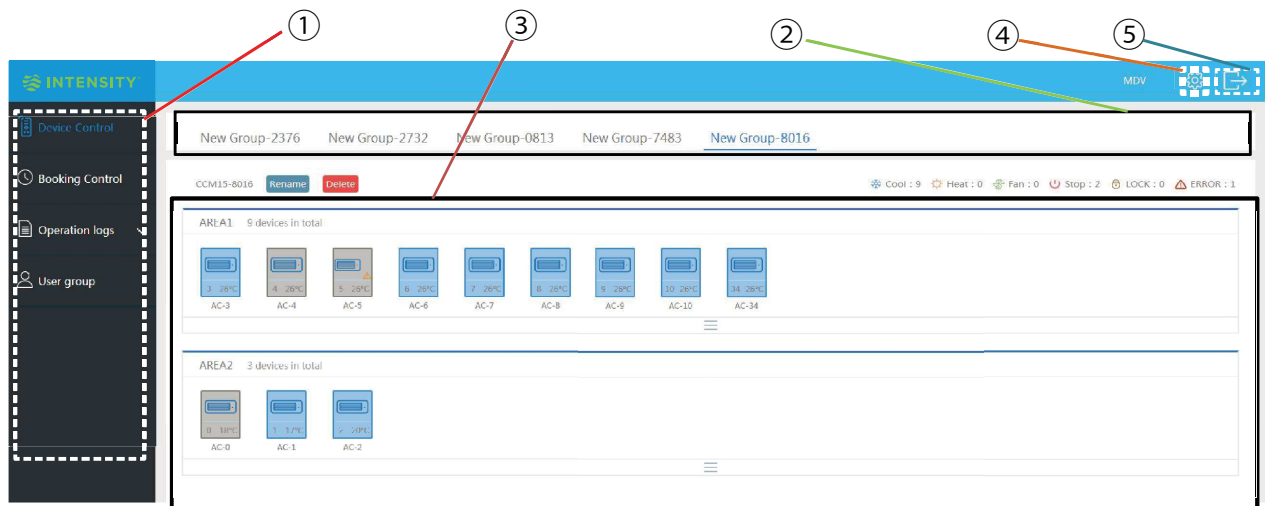

- ① It is a function list. It lists "Device Control", "Booking Control", "Operation logs", and "User group".
- ② It is a CCM15 list. It displays a list of CCM15 gateways configured via the App client. Up to 10 gateways are supported.
- ③ It is an area display pane. It displays areas and the air conditioners in an area.
- ④ setting: include display unit of the temperature, languages select and change password.
- ⑤ exist account: exist account to the main interface.

3. Area Management

3-1 Area Control Function

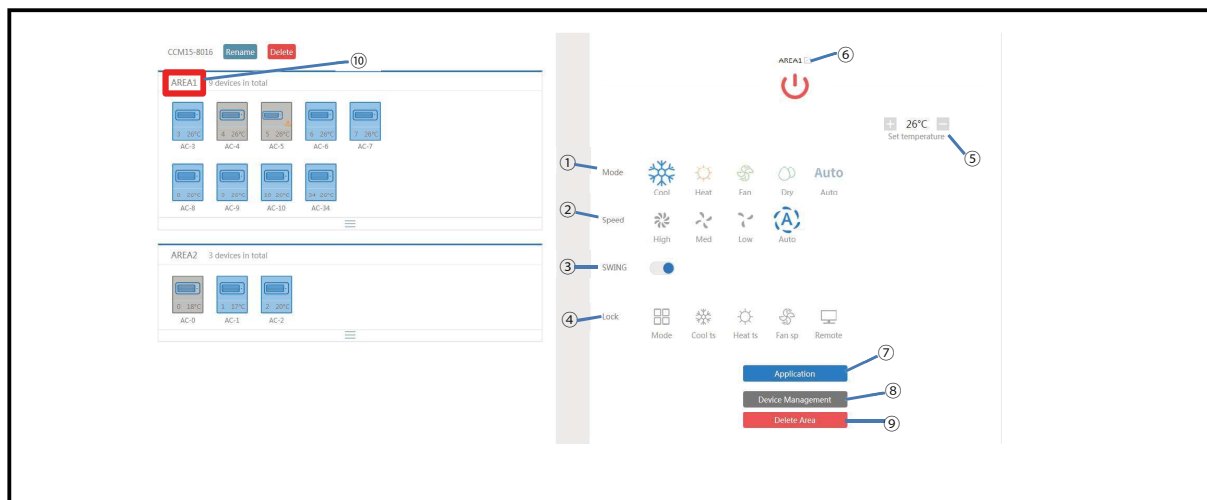

Click the area name ⑩, the right area will display the control interface

- ① "Mode": sets mode.
- ② "Speed": sets fan speed.
- ③ "Swing": determines whether to enable swing mode.
- ④ "Lock": sets the item to be locked.
- ⑤ "Set temperature": sets temperature, ranging from 17°C to 30°C (62°F to 86°F).
- ⑥ It displays an area name. Click the icon to rename it.
- ⑦ "Application": Click it to send the settings to the air conditioner.
- ⑧ "Device Management": Click it to add or delete a device.
- ⑨ "Delete Area": Click it to delete an area.

3-2 Single Control Function of Air Conditioners

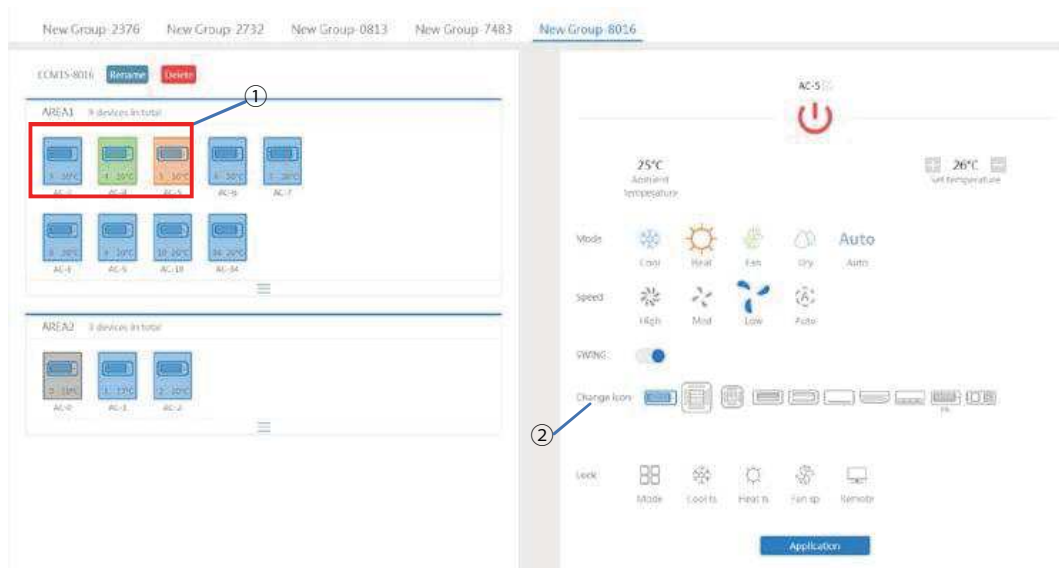

The function list is the same as that of area control. Refer to the area control function. In single control mode, the user can select the air conditioner model, indicated by ①. The area on the left displays air conditioners, indicated by ②. Mode is distinguished by different colours.

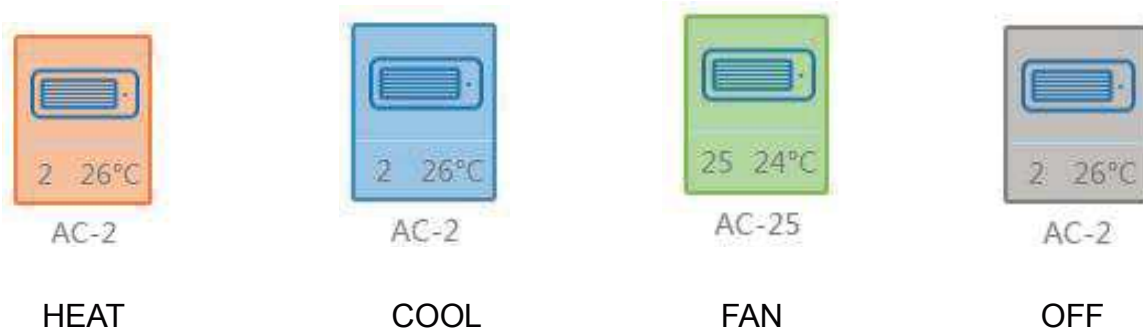

3-4 AC statistics and filter function

AC states statistics Display: calculate the number of AC with different states in one CCM15. The available states include: cooling, heating, fan only, off, lock and error. The auto mode is included in the cooling mode.

AC states filter display: display the filtered AC in a state, which is from AC systems and different area

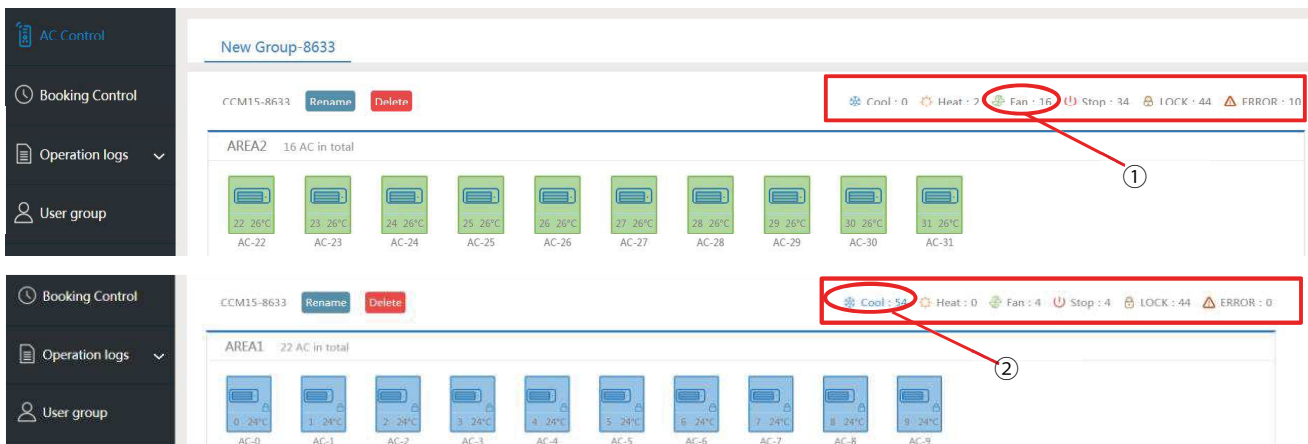

For example: click ① Fan to filter the AC in fan mode from different area
click ② Cool to filter the AC in cooling mode from different area.

4、Booking Control

Choose Booking Control to enter into the schedule setting function.

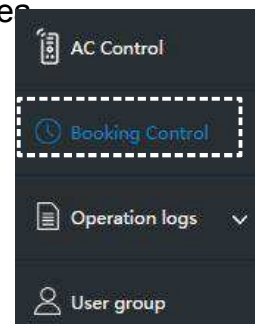

4-1 Main Interface

Type	Devices	Time	Mode	TEMP	Speed	Week	Repeat	Operation
On	Area	17:0	Auto	28°C	Auto	Mon Tue Wed Thu Fri Sat Sun	Yes	Edit Delete
On	AreaDEVICE_...	16:31	Auto	26°C	Auto	Mon Tue Wed Thu Fri Sat Sun	Yes	Edit Delete

+ Add

The main interface displays scheduled operation type, device, scheduled time, mode, temperature, fan speed, week, and repeated or not. Click "Delete" to delete a scheduled operation. Click "Edit" to edit a scheduled operation. Click "Add" to add a scheduled operation.

4-2 Adding a Scheduled Operation

Timer start Timer shutdown

Time 18 H 59 M

Devices
DEVICE_OF_NOT_AREA Close
AC-8

Mode Auto

Temperature 17°C

Speed Auto

Week Mon Tue **Wed** Thu Fri Sat Sun

Repeat Yes No

Ok Cancel

Timer start Timer shutdown

Time 18 H 59 M

Devices
DEVICE_OF_NOT_AREA Close
AC-8

Week Mon Tue **Wed** Thu Fri Sat Sun

Repeat Yes No

Ok Cancel

1. "Timer start": On this tab page, set scheduled time, device, mode, temperature, fan speed, and week, and determine whether to repeat this scheduled operation.
2. "Timer shutdown": On this tab page, set scheduled time, device, week, and determine whether to repeat this scheduled operation.

5. Logs

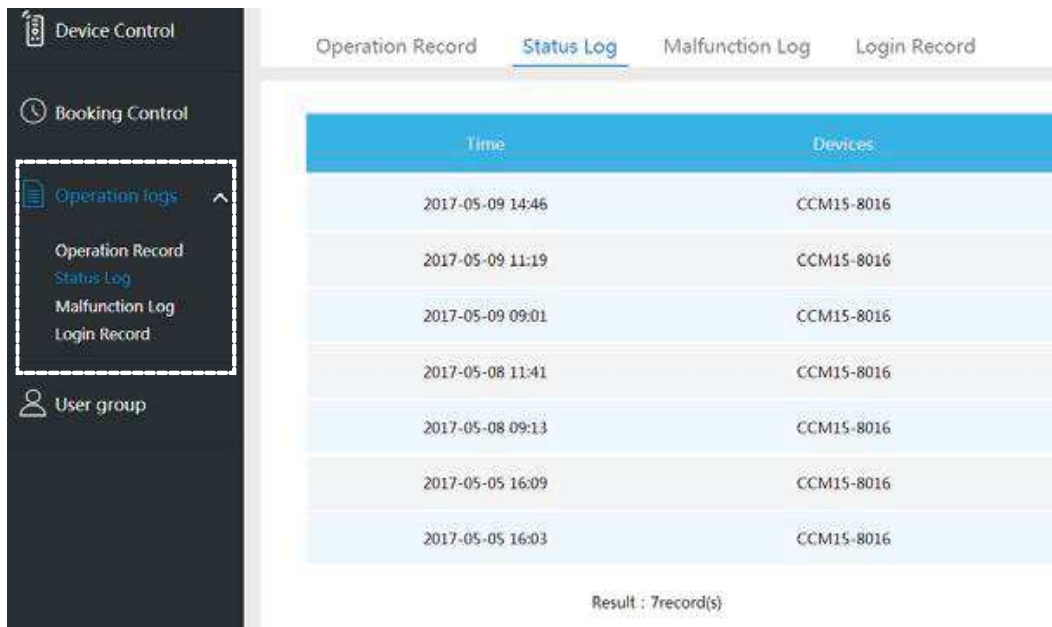

Time	Devices
2017-05-09 14:46	CCM15-8016
2017-05-09 11:19	CCM15-8016
2017-05-09 09:01	CCM15-8016
2017-05-08 11:41	CCM15-8016
2017-05-08 09:13	CCM15-8016
2017-05-05 16:09	CCM15-8016
2017-05-05 16:03	CCM15-8016

Result : 7record(s)

Logs include operation records, status logs, malfunction logs, and login records.

5-1 Operation Records

Operation	Time	User	Operating status
On	2017-05-09 14:31	MDV	Successful
Stop	2017-05-09 14:27	MDV	Successful
On	2017-05-09 14:27	MDV	Successful
Stop	2017-05-09 14:26	MDV	Successful
On Cool Auto Yes	2017-05-09 14:26	MDV	Successful
On Cool Auto Yes Unlock controller	2017-05-09 14:26	MDV	Successful
Low	2017-05-09 11:35	MDV	Successful
Low	2017-05-09 11:35	MDV	Successful
Low	2017-05-09 11:35	MDV	Successful
Low	2017-05-09 11:34	MDV	Successful

The items displayed on the "Operation Record" tab page are the same as those displayed on the App client, including mode, time, user name, and execution results.

5-2 Status Logs

Time	Device	Cabinet
2017-05-09 14:46	CCM15-8016	Online
2017-05-09 11:19	CCM15-8016	Online
2017-05-09 09:01	CCM15-8016	Online
2017-05-08 11:41	CCM15-8016	Online
2017-05-08 09:13	CCM15-8016	Online
2017-05-05 16:09	CCM15-8016	Online
2017-05-05 16:03	CCM15-8016	Online

Result : 7record(s)

The "Status Log" tab page displays online statuses of air conditioners.

5-3 Malfunction Logs

Operation Record Status Log Malfunction Log Login Record

Time	Devices	Error
2017-05-09 14:26	AC-6	E0
2017-05-09 14:26	AC-6	E0
2017-05-09 14:26	AC-6	E0
2017-05-09 14:25	AC-6	E0
2017-05-09 14:24	AC-6	E0
2017-05-09 14:24	AC-6	E0
2017-05-09 14:23	AC-6	E0
2017-05-06 14:42	AC-9	E0
2017-05-06 14:41	AC-9	E0
2017-05-06 14:41	AC-3	E0

The "Malfunction Log" tab page displays malfunction information and error codes.

5-4 Login Records

Operation Record Status Log Malfunction Log Login Record

App Login Record		Web Login Record	
Time	User	Time	User
2017-05-08 11:34	MDV	2017-05-09 14:19	MDV
2017-05-09 11:27	mdvtest2@126.com	2017-05-08 09:24	mdvtest2@126.com
2017-05-09 11:27	mdvtest2@126.com	2017-05-06 13:46	mdvtest2@126.com
2017-05-09 11:20	MDV	2017-05-05 15:33	mdvtest2@126.com
2017-05-09 09:05	mdvtest11@126.com	2017-05-05 15:33	mdvtest2@126.com
2017-05-08 17:00	MDV	2017-05-05 15:32	MDV
2017-05-08 16:40	mdvtest2@126.com		
2017-05-08 16:17	MDV		
2017-05-08 14:38	wenbin.xie@midea.com		
2017-05-08 14:31	mdvtest2@126.com		

Result : 6record(s)

Both "App Login Record" and "Web Login Record" tab pages list login information.

6 User Group Management

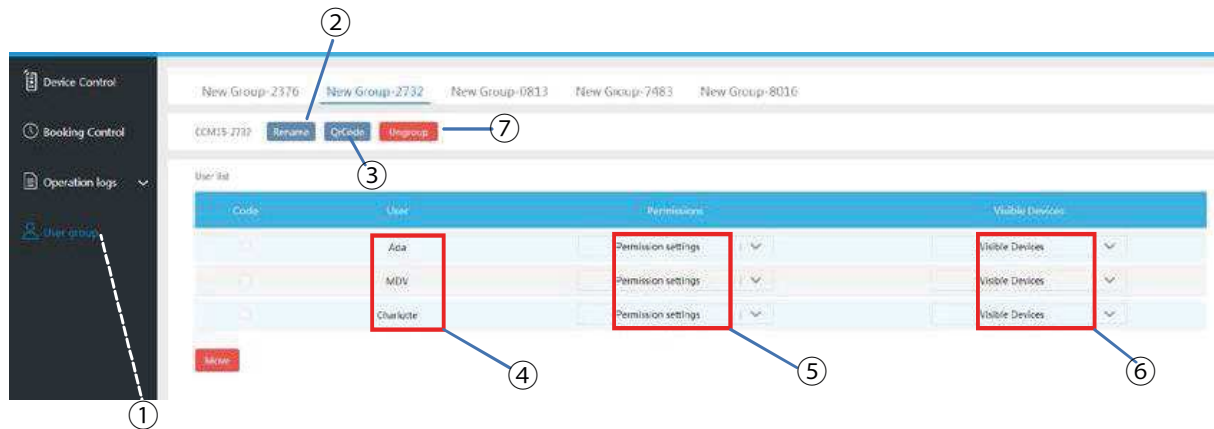

① Click it to display user group management. ② Click it to rename a group. ③ Click it to share a QR code. ④ It lists users. ⑤ Click it to set permissions. ⑥ It is a device management area. ⑦ Click it to delete a user group.

6-1 Modifying User Permissions

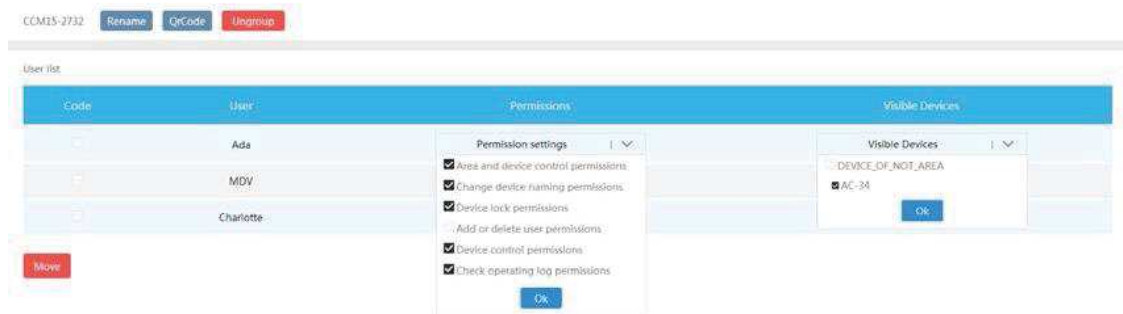

The administrator selects any member from a user group. Click the "Permission settings" drop-down list, and then select permissions. Select a visible device from the "Visible Devices" drop-down list.

6-2 Renaming a User Group

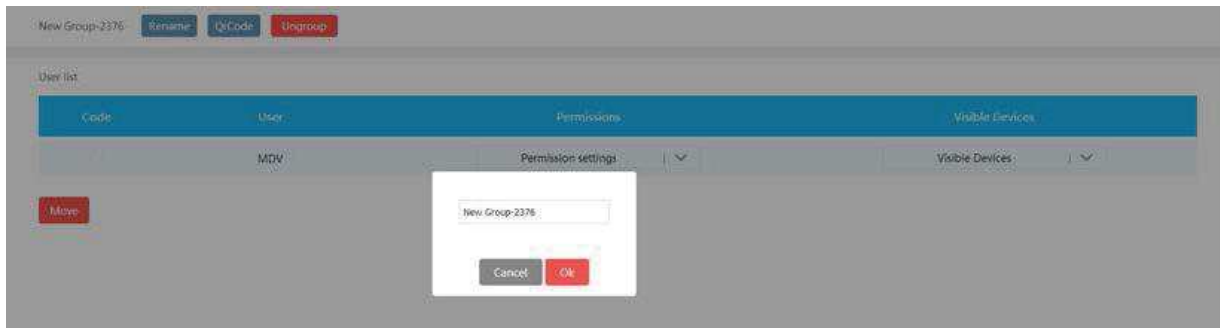

Click "Rename" to rename the selected user group.

6-3 Inviting a User

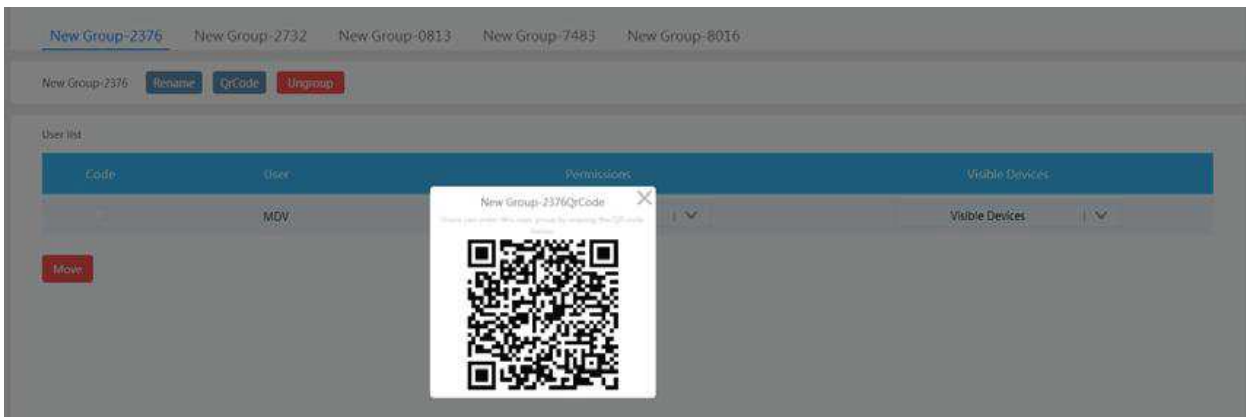

Click "QrCode" to generate a QR code of the user group. Up to 10 users are supported.

6-4 Deleting a User Group

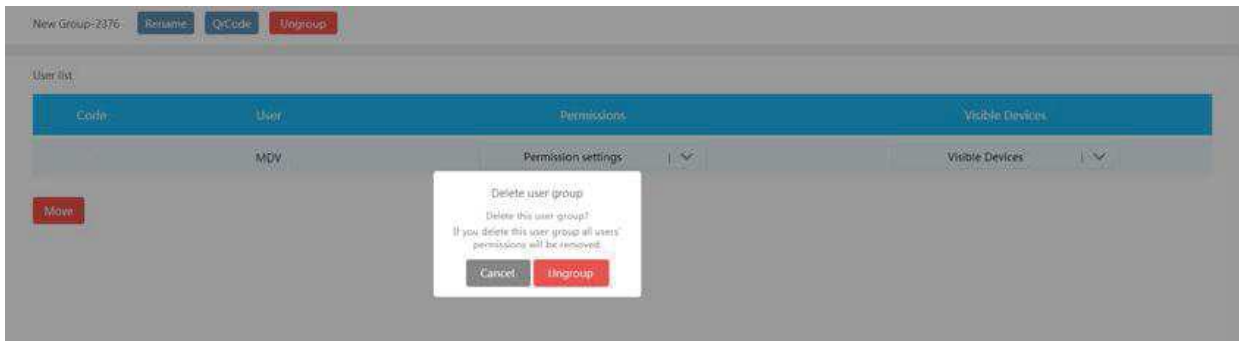

Click "Ungroup" to delete the selected user group.

7 setting

Click ④ to enter into the setting interface



① modify unit of temperature: Celsius, Fahrenheit

② set supported languages: English, French and Spanish

③ modify of the login password